

PENTAX

BATTERY GRIP D-BG4

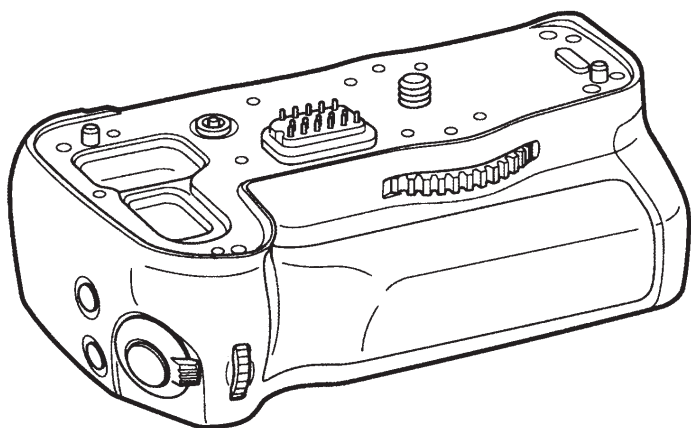

使用説明書

JA

Operating Manual

EN

Bedienungsanleitung

DE

Mode d'emploi

FR

Manual de instrucciones

ES

Manuale di Istruzioni

IT

Handleiding

NL

사용 설명서

KO

使用手冊

TC

使用手冊

SC

Thank you for purchasing the Battery Grip D-BG4. This product is an accessory to be used exclusively with the PENTAX **K-5/K-7** Digital Camera.

- Use the rechargeable lithium-ion battery D-LI90 (provided with the **K-5/K-7** . Also sold separately.) or AA lithium/Ni-MH/alkaline batteries with the D-BG4 battery grip.
- Buttons, body joints, and retractable parts are dust-proof and water-resistant.
- The camera can be used with the Battery Grip D-BG4 attached if batteries are inserted in either the camera or the grip.
- The camera operation time can be extended by inserting batteries in both the camera and the battery grip. You can select settings from [Auto Select] (factory default setting), [Body First] or [Grip First] in [Select Battery] in the [ Set-up 3] menu.
- The camera case cannot be used when the battery grip is attached.

FOR SAFE USE

Although we have carefully designed this product for safe operation, please be sure to follow precautions given on this page.

 **WARNING** This mark indicates that violating this item could cause serious personal injuries.

 **CAUTION** This mark indicates precautions that, if not followed, could result in minor or medium injuries to the user or damage to the equipment.

 **WARNING**

- Do not disassemble or modify the battery grip. High voltage areas are present inside the equipment, with the risk of electric shock.
- If the battery grip interior is exposed due to dropping or otherwise damaging the battery grip, never touch the exposed portion. There is a risk of electric shock.

 **CAUTION**

- Never try to disassemble or short the batteries. Also do not dispose of the batteries in fire, as they may explode.
- Misuse of the batteries can cause hazards such as leakage, overheating, explosion, etc. The batteries should be inserted with “+” and “-” side facing correctly.
- Remove the batteries from the grip immediately if it becomes hot or begins to smoke. Be careful not to burn yourself during removal.

Please read “About the Battery” on page 2 of the camera operating manual and use the batteries carefully.



NAMES OF WORKING PARTS

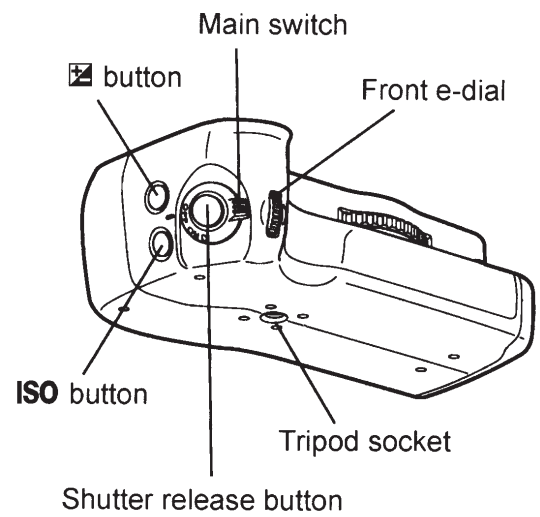
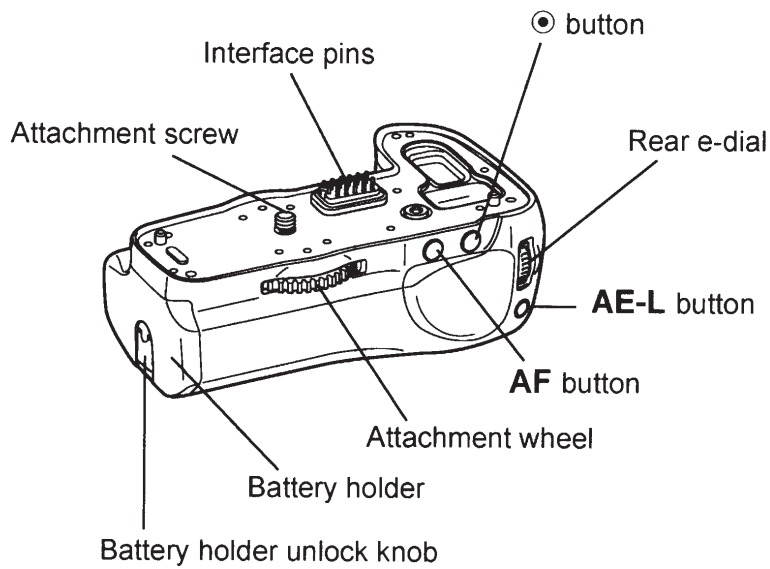

* The Battery Grip D-BG4 is supplied with battery holders for both the lithium-ion battery D-LI90 and AA batteries.

INSTALLING THE BATTERIES

Use the rechargeable **lithium-ion battery D-LI90** (provided with the **K-5/K-7**. Also sold separately.) or six **AA batteries** of the same type (lithium/Ni-MH/alkaline).

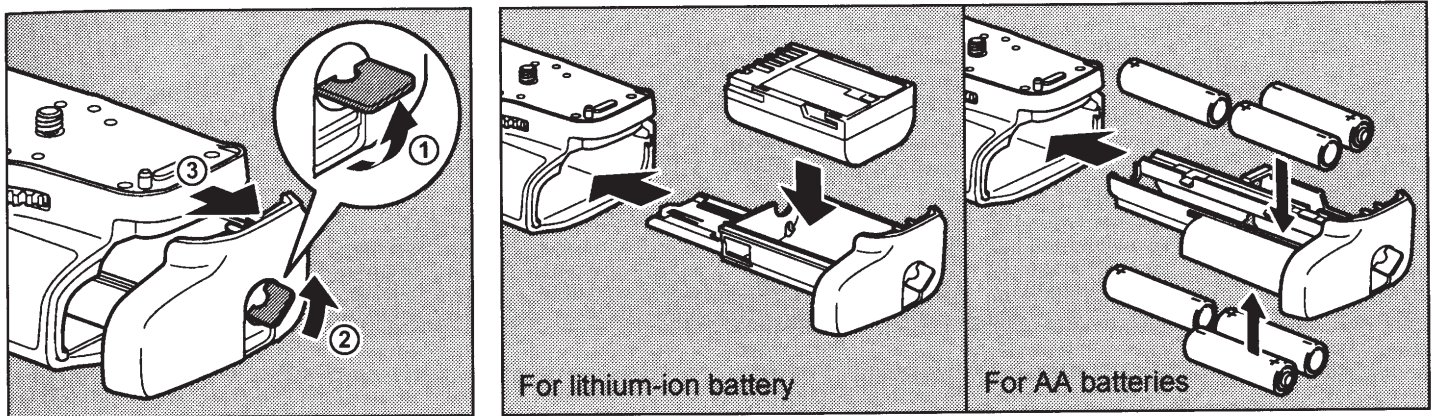

1 Pull out the battery holder.

① Lift the battery holder unlock knob. ② Turn the knob towards OPEN to unlock. ③ Pull out the battery holder.

2 Insert the lithium-ion battery or AA batteries.

Position the lithium-ion battery so that the ▲ mark points down, and insert the battery in the orientation shown on the battery holder. For AA batteries, insert the batteries in the orientation shown on the battery holder, taking care not to reverse the polarity (+, -).

3 Stow the battery holder.

Stow the battery holder by performing Step 1 in reverse order.

↳ Memo

- A spare SD Memory Card can be stored in the end section of the lithium-ion battery holder.

ATTACHING THE BATTERY GRIP TO THE CAMERA

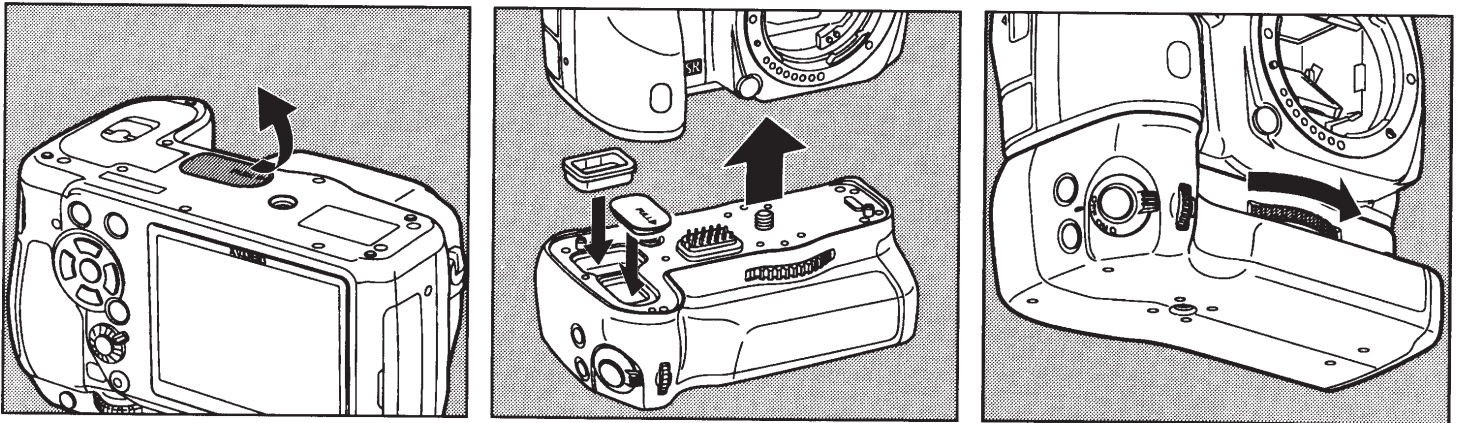

- 1 Open the battery grip connection cover on the camera, and remove the interface pins cap on the battery grip.
- 2 Attach the battery grip to the camera by fitting the interface pins and attachment screw of the battery grip to the battery grip connection terminal and tripod socket of the camera as shown above.
- 3 Secure the battery grip by turning the attachment wheel firmly in the direction of the arrow as shown above.

⚠ CAUTION

- Make sure the camera and the battery grip are turned off before attaching.
- Leave the cap on when not using the battery grip. Do not touch the interface pins with the cap off. You can store the interface pins cap in the cavity of the battery grip (see illustration in step 2).
- You can store the battery grip connection cover of the camera in the cavity of the battery grip after removing from the camera in step 1 (see illustration in step 2). When storing the cover, push it down straight with your both thumbs.

TAKING PICTURES WITH THE CAMERA IN THE VERTICAL POSITION

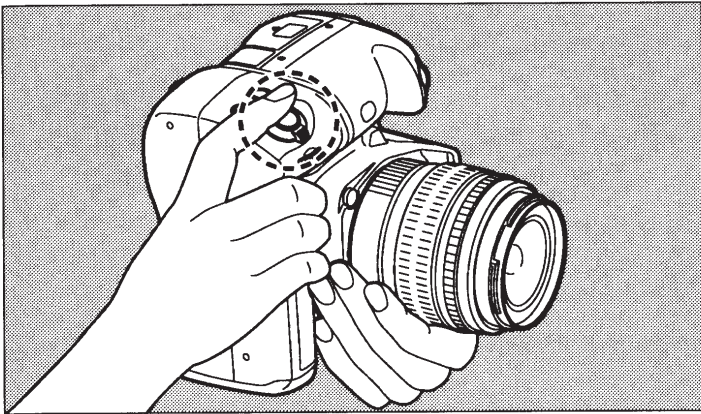

Use the shutter release button on the battery grip when taking pictures with the camera in the vertical position.

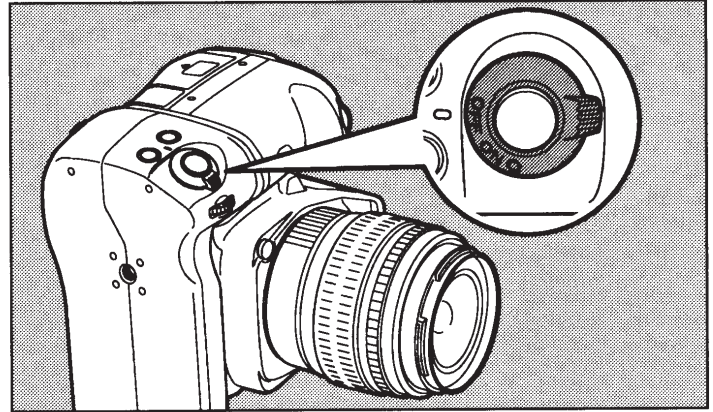



Make sure to turn on the battery grip before attempting to operate any of the buttons or dials on the battery grip. However, the camera can still be operated by its own control even if the battery grip is turned off.

Memo

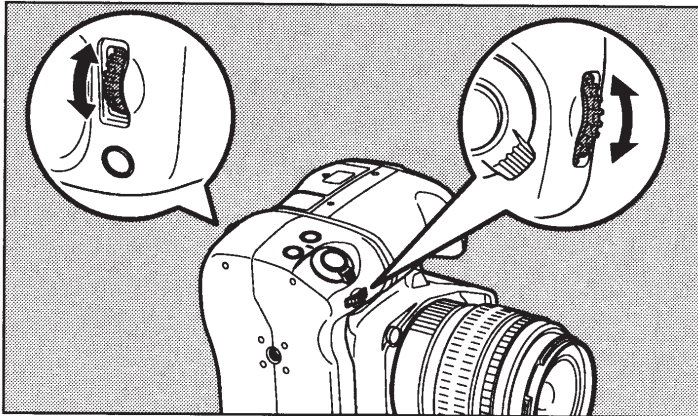
- It is recommended to turn off the battery grip when using the camera in a position other than the vertical position as the switch may accidentally be pressed.



The front e-dial, rear e-dial,  button, **ISO** button, **AE-L** button,  button, and **AF** button are available like the levers, dials, and buttons on the camera.

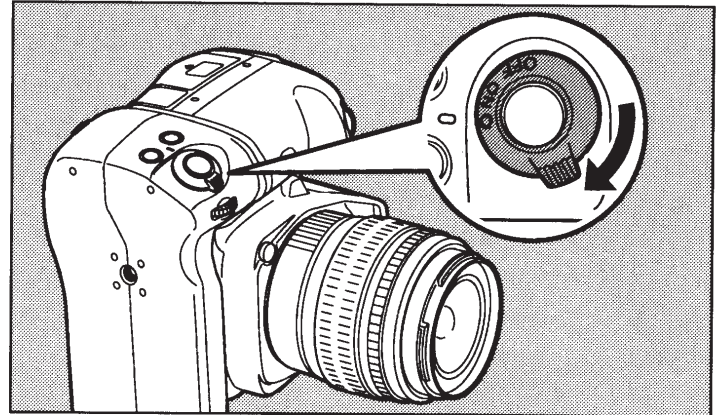

Turn the main switch to  to check the depth of field or display Digital Preview.

Memo

- If the front e-dial or rear e-dial on either the camera or battery grip is not clicked into place, the dials may fail to operate. If the dials on the camera do not operate, try turning the dials on the battery grip slightly. Alternatively, if the dials on the battery grip do not operate, try turning the dials on the camera slightly.

SPECIFICATIONS

Camera: *K-5/K-7*

Batteries: Rechargeable lithium-ion battery D-LI90, six AA lithium/Ni-MH/alkaline batteries

Dimensions (W × H × D): Approximately 132.5 × 42 × 75 mm (excluding protrusions)

Weight: Approx. 260 g (with lithium-ion battery holder excluding a lithium-ion battery)
Approx. 245 g (with AA battery holder excluding six AA batteries)

Specifications and external dimensions are subject to change without notice.

- For the number of recordable images and playback time, visit the PENTAX website.



For customers in the USA

STATEMENT OF FCC COMPLIANCE

This device complies with Part 15 of the FCC Rules. Operation is subject to the following two conditions:

(1) This device may not cause harmful interference, and (2) this device must accept any interference received, including interference that may cause undesired operation.

Changes or modifications not approved by the party responsible for compliance could void the user's authority to operate the equipment.

This equipment has been tested and found to comply with the limits for a Class B digital device, pursuant to part 15 of the FCC Rules.

These limits are designed to provide reasonable protection against harmful interference in a residential installation. This equipment generates, uses and can radiate radio frequency energy and, if not installed and used in accordance with the instructions, may cause harmful interference to radio communications.

However, there is no guarantee that interference will not occur in a particular installation. If this equipment does cause harmful interference to radio or television reception, which can be determined by turning the equipment off and on, the user is encouraged to try to correct the interference by one or more of the following measures:

Reorient or relocate the receiving antenna.

Increase the separation between the equipment and receiver.

Connect the equipment into an outlet on a circuit different from that to which the receiver is connected.

Consult the dealer or an experienced radio/TV technician for help.

For customers in Canada

This Class B digital apparatus complies with Canadian ICES-003.

Pour les utilisateurs au Canada

Cet appareil numérique de la classe B est conforme à la norme NMB-003 du Canada.

HOYA CORPORATION PENTAX Imaging Systems Division	2-35-7, Maeno-cho, Itabashi-ku, Tokyo 174-8639, JAPAN (http://www.pentax.jp)
PENTAX Europe Imaging Systems S.A.S. (European Headquarters)	112 Quai de Bezons, B.P. 204, 95106 Argenteuil Cedex, FRANCE (HQ - http://www.pentax.eu) (France - http://www.pentax.fr)
PENTAX Imaging Systems GmbH	Julius-Vosseler-Strasse 104, 22527 Hamburg, GERMANY (http://www.pentax.de)
PENTAX Imaging Systems Limited	PENTAX House, Heron Drive, Langley, Slough, Berks SL3 8PN, U.K. (http://www.pentax.co.uk)
PENTAX Imaging Company A Division of PENTAX of America, Inc.	(Headquarters) 600 12th Street, Suite 300 Golden, Colorado 80401, U.S.A. (PENTAX Service Department) 250 North 54th Street Chandler, Arizona 85226, U.S.A. (http://www.pentaximaging.com)
PENTAX Canada Inc.	1770 Argentia Road Mississauga, Ontario L5N 3S7, CANADA (http://www.pentax.ca)
PENTAX Trading (SHANGHAI) Limited	23D, Jun Yao International Plaza, 789 Zhaojiabang Road, Xu Hui District, Shanghai, 200032 CHINA (http://www.pentax.com.cn)

53297 JA/EN/DE/FR/ES/IT/NL/KO/TC/SC

菲律宾印刷
Copyright © HOYA CORPORATION 2011
H02-201103 Printed in Philippines

PENTAX

社名変更のご案内

HOYA 株式会社 PENTAX イメージング・システム事業部は、2011 年 10 月 1 日をもって、ペンタックスリコーイメージング株式会社となります。

(英文名：PENTAX RICOH IMAGING COMPANY, LTD.)

今後とも、お客様にこれまで以上にご満足いただける製品を提供してまいりますので、引き続きご支援ご愛顧を賜りますよう宜しくお願い申し上げます。

公司更名通知

HOYA CORPORATION PENTAX Imaging Systems Division 将于 2011 年 10 月 1 日正式更名为 PENTAX RICOH IMAGING COMPANY, LTD.。

今后，PENTAX RICOH IMAGING COMPANY, LTD. 将传承消费者广为熟知的宾得 (PENTAX) 品牌，继续为广大用户提供满意的产品，希望能得到广大用户一如既往的支持和爱护。

Notification of Change in Company Name

HOYA CORPORATION PENTAX Imaging Systems Division will officially be renamed PENTAX RICOH IMAGING COMPANY, LTD. on October 1, 2011.

We will continue to market a fine line of products under the familiar PENTAX brand to satisfy your demands and requirements.

We thank you for your continued support and patronage to PENTAX RICOH IMAGING COMPANY, LTD. and our PENTAX-brand products.

Annonce du changement de nom de notre société

La société HOYA CORPORATION PENTAX Imaging Systems Division prendra le nom de PENTAX RICOH IMAGING COMPANY, LTD. à partir du 1er octobre 2011.

Suite à notre rachat par la société RICOH, et afin de satisfaire les possesseurs d'appareils photo PENTAX et conserver la notoriété de notre marque depuis presque un siècle, nos produits conserveront le nom PENTAX.

Nous tenons à vous remercier par avance pour votre fidélité et espérons que vous continuerez à faire confiance à PENTAX RICOH IMAGING COMPANY, LTD. et aux produits PENTAX.

PENTAX Worldwide Service Network

- Your PENTAX product will be repaired at the PENTAX service centers listed hereunder.
- The International Warranty service will be provided at the service centers marked by "○" located in other than the country/area where the product was originally purchased. In case you request the International Warranty service, present the valid International Warranty card together with the product. We recommend that you present the original copy or copy of purchase receipt.
- To obtain the International Warranty card, consult with the dealer or supplier from where you originally purchased the product. International Warranty card will be issued at the service centers marked by "○" where you originally purchased the product in the following list. For further details, please refer to the conditions mentioned in the International Warranty card.
- Contents of this document are subject to change without notice.

Weltweites PENTAX-Kundendienstnetz

- Ihr PENTAX-Produkt wird von den nachstehend aufgelisteten PENTAX-Kundendienststellen repariert.
- Der internationale Garantieservice ist bei den mit "○" markierten Kundendienststellen erhältlich, die außerhalb des Landes/Gebietes des Erstkaufs des Produkts liegen. Für den Fall, daß Sie den internationalen Garantieservice in Anspruch nehmen, reichen Sie bitte die gültige internationale Garantiekarte zusammen mit dem Produkt ein. Es wird empfohlen, das Original oder eine Kopie der Kaufquittung vorzulegen.
- Um die internationale Garantiekarte zu erhalten, wenden Sie sich bitte an den Händler oder Lieferanten, bei dem Sie das Produkt ursprünglich gekauft haben. Die internationale Garantiekarte wird von den mit "○" markierten Kundendienststellen ausgegeben, wo Sie das Produkt ursprünglich gekauft haben. Weitere Einzelheiten entnehmen Sie bitte den auf der internationalen Garantiekarte angegebenen Bedingungen.
- Wir behalten uns das Recht auf Änderungen des Inhalts dieses Dokuments vor.

Réseau mondial d'après-vente PENTAX

- Votre produit PENTAX sera réparé dans l'un des centres de service après-vente dont la liste figure ci-après.
- Le service de la Garantie Internationale est disponible dans les centres d'après-vente marqués par "○" situés en dehors du pays ou de la région de l'achat original. Au cas où vous devez avoir recours au service offert par la Garantie Internationale, présentez la carte de Garantie Internationale valide avec le produit. Il est recommandé de présenter aussi l'original ou la copie de la preuve d'achat.
- Pour obtenir la carte de Garantie Internationale, renseignez-vous auprès du revendeur ou du fournisseur où vous avez acheté votre produit. La carte de Garantie Internationale sera délivrée dans les centres de service après-vente marqués d'un "○" (où vous avez fait l'acquisition initiale du produit). Pour plus d'informations, veuillez vous reporter aux conditions décrites sur la carte de Garantie Internationale.
- Le contenu de ce document est sujet à modifications sans préavis.

Red Mundial de Servicio PENTAX

- Su producto PENTAX será reparado en las estaciones de servicio listadas aquí abajo.
- El servicio de la Garantía Internacional será proporcionado en las estaciones de servicio marcadas con una "○" ubicada en un sitio que no sea el país/área donde se adquirió originalmente el producto. En caso de que Ud. solicite el servicio de la Garantía Internacional, presente la Tarjeta de Garantía Internacional válida junto con el producto. Le recomendamos que presente también el original o la copia de su recibo de compra.
- Para obtener la Tarjeta de Garantía Internacional, consulte a su concesionario o proveedor al que Ud. compró originalmente el producto. La Tarjeta de Garantía Internacional estará disponible en las estaciones de servicio marcadas con una "○" en las que compró originalmente el producto. Para más detalles, consulte las condiciones mencionadas en la Tarjeta de Garantía Internacional.
- El contenido de este documento está sujeto a cambios sin previo aviso.

Rede Mundial de Serviços PENTAX

- O seu produto PENTAX deverá ser reparado nas estações de serviços PENTAX listadas abaixo.
- O serviço de Garantia Internacional poderá ser fornecido pelas estações de serviço assinaladas com um "○", existentes em outras localidades que não o país/área em que o produto foi adquirido originalmente. Para solicitar o serviço de Garantia Internacional, apresente o cartão de Garantia Internacional válido junto com o produto. Recomendamos a apresentação do original ou da cópia do recibo de compra.
- Para obter o cartão de Garantia Internacional, consulte o seu revendedor ou fornecedor onde você adquiriu o produto originalmente. O cartão de Garantia Internacional será emitido nas estações de serviços marcadas com "○" onde você adquiriu o produto originalmente. Para mais detalhes, por favor, leia as condições mencionadas no cartão de Garantia Internacional.
- O conteúdo deste documento está sujeito a modificações sem prévio aviso.

ペンタックス・ワールドワイド・サービス・ネットワーク

- 本製品が万一故障した場合は、このリストに記載されている当社指定のペンタックスサービスステーションへ修理をお願いします。
- 国際保証書による海外での保証修理は、○印の付いたサービスステーションで承ります。修理の際は、必ず有効な国際保証書を添付の上お申し付けください。海外で保証修理を受けられる場合、領収書の提示を求められる場合がありますので、国際保証書と一緒に添付することをお勧めいたします。
- 国際保証書は製品をご購入された国の○印の付いているサービスステーションで発行いたします。保証の内容は、国際保証書をお読みください。
- 本書の内容は、予告なしに変更することがあります。

PENTAX 全球維修服務網絡

- 下列清單中的 PENTAX 維修服務站可修理您的 PENTAX 產品。
- 原購國家 / 地區境外的國際保用維修服務站已標上○符號。顧客要求維修服務時，請出示有效的國際保用卡及產品。PENTAX 建議同時出示購貨收據正本或副本。
- 如果要領取國際保用卡，請聯絡原來購買產品的經銷商或供應商。可從原購國家或地區的標有"○"符號的維修服務站領取國際保用卡。詳情請參閱國際保用卡註明的條款。
- 本文件的内容如有更改，恕不另行通知。

PENTAX 全球维修服务网络

- 下列清单中的 PENTAX 维修服务站可修理您的 PENTAX 产品。
- 原购国家 / 地区境外的国际保用维修服务站已标上○符号。顾客要求维修服务时，请出示有效的国际保用卡及产品。PENTAX 建议同时出示购货收据正本或副本。
- 如果要领取国际保用卡，请联络原来购买产品的经销商或供应商。可从原购国家或地区的标有"○"符号的维修服务站领取国际保用卡。详情请参阅国际保用卡注明的条款。
- 本文件的内容如有更改，恕不另行通知。

NORTH & CENTRAL AMERICA

U.S.A.	
○ PENTAX Imaging Company	☎1-800-877-0155
A Division of PENTAX of America, Inc.	
PENTAX Service Department	☎1-877-269-7179
250 North 54th Street Chandler, AZ 85226	
○ Precision Camera and Video Repair Inc.	☎1-860-749-7380
3 Anngina Drive Enfield, CT 06082	
○ Camera Repair Japan Co.	☎1-770-849-0555
3435 Breckinridge Blvd, Suite 130, Duluth, GA 30096	
○ United Camera & Binocular Repair Corp.	☎1-630-595-2525
Thorndale Business Center 1062 Tower Lane, Bensenville, IL 60106	
○ Forster's Camera Service, Inc.	☎1-801-487-1288
40 W. 2950 South, Salt Lake City, UT 84115	
○ California Precision Service	☎1-916-451-1335
1714, 28 th Street, Sacramento, CA 95816	
○ Picture Perfect UnLtd.	☎1-818-998-5204
25876 The Old Road, Suite 300, Valencia, CA 91381	
○ Photo Tech	☎1-808-952-6161
1413 South King St., Suite 201, Honolulu, HI 96814-4309	
○ Advance Camera Repair and Sales	☎1-503-292-6996
8124 SW Bvrtin Hillsdale HWY., Portland, OR 97225	
○ C. R. I. S.	☎1-480-940-1103
250 N. 54 th Street, Chandler, AZ 85226	

Canada	
○ PENTAX Canada Inc.	☎1-905-286-5590
1770 Argentea Road Mississauga, Ontario L5N 3S7	
E-mail: service@pentax.ca	

Costa Rica	
Dima Industrial Y Comercial, S.A.	☎506-2222-3969/2257-1772
Avenida Central, Calles 3 Y 5 San Jose	

Mexico	
Jorge Meyer Broissin, S. A. de C. V.	☎52-5-560-20-44/373-95-20
Av. San Mateo #35-B, Fracc. San Mateo, Col. Boulevardes Naucalpan de Juarez. Edo. de Mexico C.P. 53140	

ASIA

Indonesia	
PT. Aneka Warna Indah	☎62-21-6511009
Jl. Gunung Sahari No. 50 A Jakarta, Indonesia 10610	

Singapore	
Emjay Enterprises (1984) Pte. Ltd.	☎65-6338-8948
111 North Bridge Road, #14-01 Peninsula Plaza, Singapore 179098	

Korea	
PENTAX Korea Customer Service Center	☎82-2-2024-0150
10th fl, Sam Hwan Digital Venture Tower, SungSu-Dong 2-Ga 280-13, SungDong-Gu, Seoul	
PENTAX A/S Center	☎82-2-757-9517
6th fl, Bong San Bldg., 4-3 Gwansu-Dong, Jongno-Gu, Seoul	

Camera Daehak Byungwon	☎82-42-254-1110
1st fl, Hwawon Bldg., 157-2 Eunhaeng-Dong, Jung-Gu, Daejeon	
GWANGJU PENTAX Service Center	☎82-62-651-5555
94-180 Im-Dong, Buk-Gu, Gwangju	
Digital i	☎82-2-749-2799
A-43, Shin Kwan Kwang Jang fl, Electronic Land, HanGang-No 3-Ga 16-9, Yongsan-Gu, Seoul	
YeonTech	☎82-53-428-5777
2nd fl, DongMun-Dong 1-20, Jung-Gu, Daegu	

Malaysia	
○ DSC World Sdn. Bhd	☎60-3-2142-0208
Futuromic Center at Lot 08-41, level 8, West Wing, Berjaya Times Square, No.1, Jalan Imbi, 55100 Kuala Lumpur	
E-mail: admin@dscworld.com.my	

Philippines	
Super East Asia Enterprises, Inc.	☎63-2-570-8415
#19 Don A. Egea st., Brgy. Pinagkaisahan 1111 Quezon City	

Thailand	
○ Central Trading Co., Ltd.	☎66-2-229-7000/7674
3388/25-37, 51-53 and 82-85 Srinrat Building 8-11 th , 15 th , 23 rd Floor Rama 4 Rd. Klong-Toey Bangkok 10110	

China	
Jebsen & CO. (China) Ltd. Beijing Service Center	☎86-10-6518-7889
10th Floor, Tower 2, Henderson Center, No.18, Jian Guo Men Nei Avenue, Beijing 100005	
Jebsen & CO. (China) Ltd. Guangzhou Service Center	☎86-20-8713-7262
23rd Floor, Guangdong Telecom Plaza, No.18, No.2 Zhong Shan Road, Guangzhou 510081	
Xin Guang Optical Instrument Co., Ltd.	☎86-21-6418-2293/86-400-820-7756-835
3F, No.141 South ShanXi Road, LuWan District, ShangHai 200020	

Hong Kong	
○ Jebsen & Co., Ltd.	☎852-2926-2300
10/F, Continental Building, 17 Wang Chiu Road, Kowloon Bay, Kowloon, Hong Kong	

Taiwan	
○ WZC International Co., Ltd.	☎886-2-23816132
8Fl., 37, Sec. 1, Kai-Feng Street Taipei	

Japan	
○ PENTAX Forum	☎81-3-3348-2941
MB (Middle Basement) Floor, Shinjuku Center Building, 1-25-1, Nishi-Shinjuku, Shinjuku-ku, Tokyo 163-0690	
○ PENTAX Tokyo Service Center	☎81-3-3960-5140
3F Heliost II BLDG. 1-12-11, Funado, Itabashi-ku, Tokyo 174-0041	
○ PENTAX Osaka Service Center	☎81-6-6271-7996
Pearl Bldg. 2/F, 17-9, Minami-Senba 1-chome, Chuo-ku, Osaka 542-0081	
○ Camera Service Nagoya Co.	☎81-52-485-9612
2-13 Takebashi-cho, Nakamura-ku, Nagoya 453-0016	
○ Higasa Camera Service Co.	☎81-87-887-1920
9-18, Higashihazemachi, Takamatsu 761-8054	
○ Camera Service Kagoshima Co.	☎81-99-837-8556
2nd Floor, 1-2-3, Higashi-Taniyama, Kagoshima 891-0113	

EUROPE

Andorra (Principality of)	
○ S.I.A. Ltd.	☎376-803-377
C/Maria Pla 26, Andorra la Vella	
Austria	
○ Rüdiger Maerz GmbH	☎49-40-7314077
Süderstrasse 75a 20097 Hamburg	
Belgium	
○ H. De Beukelaer & Co n.v./s.a.	☎32-3-870-5900
Boomsesteenweg 77 B-2630 Aartselaar	
Bulgaria	
VIP Trading Ltd. (Commercial Office)	☎359-2-980-5065
15 Stara planina Str., 1000 Sofia	
LAS Service (Service Center)	☎359-2-8580102
jk. Strebishte, Gotze Delchev Blvd, bl.1, Sofia 1404	
Canary Islands	
○ M.U. Daswani	☎34-922-201-710
Subida al Mayorazgo, 4F Pol. Ind. El Mayorazgo - 38110 Santa Cruz de Tenerife	
○ M.U. Daswani	☎34-928-46-45-27
La Naval 124, Puerto de la Luz, 35008 Las Palmas de Gran Canaria	
Croatia	
Neo Orbis d.o.o.	☎385-1-2944447
Pokornoga 8, 10000 Zagreb	
INFODATA (Service Center in Croatia)	☎385-1-2409140
CMP Savica Sancic 111, 10000 Zagreb	
Cyprus	
○ Cyprus Trading Corporation Public Ltd.	☎357-22-740450
Shacolas House Athalassa, P.O. Box 21744, 1589 Nicosia	
Czech Republic	
Pentec s.r.o.	☎420-2-20-610-753
Velešlavinska 19/30, 162 00 Praha 6	
○ Foto-Servis	☎420-2-22-711-045
Čs. armády 16 (entrance Eliášova 25), 160 00 Praha 6	
Denmark	
Focus Nordic Denmark AS	☎45-4485 3400
Erhvervsvej 30, 2610 Rødovre	
Estonia	
Nordic Digital AS	☎372-7-337700
Tõöstuse tee 6, Tõrvandi, Ülenurme vald, 61715 Tartumaa	
Finland	
Focus Image Nordic Oy	☎358-9-4730 8451
Pakkalankuja 7, 01510 VANTAA	
France	
○ PM2S S.A.S	☎33-1-30-68-67-66
9, Avenue d'Alembert 78190 Trappes	
MEDAS SA (Sport Optics Only)	☎33-4-70-30-19-30
57 avenue Doumer 03206 Vichy Cedex	
Germany	
○ Rüdiger Maerz GmbH	☎49-40-7314077
Süderstrasse 75a 20097 Hamburg	
○ Rüdiger Maerz GmbH	☎49-30-3416993
Arosler Allee 60 13407 Berlin-Reinickendorf	
○ TRITEC GmbH	☎49-05-3029181
Kolpingstraße 5 38159 Vechelde	
Gibraltar	
A. G. Day & Sons Ltd.	☎350-74-427
42 Turnbulls Lane Gibraltar	
Greece	
○ Salcofot S.A.	☎30-210-32-17-506
43, Stadiou Str, 105 59 Athens	
○ Salcofot S.A.	☎30-231-0278-600
17, Venizelos Str., 546 24 Thessaloniki	
Hungary	
○ Camera Ltd.	☎36-1-266-8085
Somogyi B. u. 19, 1085 Budapest	
Iceland	
Gisli Gestsson	☎354-5-68-04-50/51
Skipholt 31, 105 Reykjavik	
Italy	
○ FOWA S.p.A.	☎39-011-81441
V.Tabacchi Odoardo 29, 10132 Torino (TO)	
Latvia	
Baltijas Servisa Centrs	☎371-6-70-70-520
Brivibas str. 201, Riga, LV1039	
Lithuania	
Vilbros Prekyba UAB	☎370-5-2394118
Svitrigailos str 11B, 03228 Vilnius	
Malta	
Fotetek Services Ltd.	☎356-21-333808
22-26 Triq H. Calleja Schembri, Msida MSD1741	
Netherlands	
○ De Beukelaer BV	☎31-184-43-30-50
Stationspark 430, 3364 DA Siedrecht	
Norway	
○ Focus Nordic Norway AS	☎47-67-173700
Rudssletta 97, N-1351 Rud	
Poland	
○ Apollo Electronics Sp. z o.o.	☎48-22-464-58-00
ul. Poleczki 13, 02-822 Warszawa	
Portugal	
○ REFLECTA S.A.	☎34-93-339-1154
C/Europa 12, 08028 Barcelona	
Romania	
Focus Trading 94 srl	☎40-21-2300107
Intr. Tudor Stefan 10, Sector 1, 011657 Bucharest	
Russia	
○ Pentar Co. Ltd.,	☎7-812-3467942
Varshavskaya Str., 23/1, 196128 St. Petersburg	
Pentar Moscow	☎7-495-9374058
Akademika Korolyova Str. 5, office 236, 129515 Moscow	
Slovakia	
○ EXAPRO Slovakia spol. s.r.o.	☎421-56-6441035
Masarykova 49, 07101 Michalovce	
Slovenia	
Foto Beseničar. Uroš Fabjan S.P.	☎386-1-2800800
Dunajska 57, 1000 Ljubljana	

Spain	
○ REFLECTA S.A.	☎34-93-339-1154
C/Europa 12, 08028 Barcelona	
Fotoservicio SL	☎34-93-2073883
Sicilia, 382 08025 Barcelona	
Sweden	
Focus Nordic AB	☎46-31-336 23 00
Laxfiskevägen 16 S-433 38 Partille	
○ Kameron Service Kungorsor	☎46-227-12740
Kungsgatan 30 S-736 32 KUNGSOR	
Switzerland	
○ Jäger AG	☎41-56-641-2144
CH-5620 Bremgarten Postfach 2135	
Turkey	
○ ELITEL FOTOGRAFICILIK	☎90-212-522-43-30
Babalı Cadd, Dr Ziya Gün Han 28, Kat 3/36, Cağaloğlu - İstanbul	
○ OPTIK ELEKTRONIK	☎90-212-514-47-96
Arpacilar Caddesi, Anadolu Han k:1, no:1 Eminönü - İstanbul	
United Kingdom	
○ JP Service Solutions	☎44-1-782-753-350
Hempstalls Lane, Newcastle under Lyme Staffordshire ST5 0SW	

MIDDLE EAST

Bahrain	
○ Yaqub Stores W.L.L.	☎973-17-210956
P.O. Box 158, Manama	
Iran	
○ See Goal Co. Ltd.	☎98-21-66954090-91
No.6, HosseinAli Pour Alley, Enghelab Sq., P.O. Box 13185-934, Tehran	
Israel	
○ Karat Israel Ltd.	☎972-3-9774302
The New Karat Building, Hevel Modiin Industrial Park, P.O.Box969, Shoam 73142	
Kuwait	
○ Boushahri Group W.L.L.	☎965-572-90-00
P.O. Box 547, 13006 Safat	
Lebanon	
Gulbenk Corporation	☎961-4-723778
421, Saboundjian building, Jal-EI-Dib Highway, Jal-EI-Dib	
Gulbenk Corporation	☎961-1-738002
Sanayegh, Al Fabh Building P.O. Box 11-3111, Beirut	
Hagop Saadjiyan	☎961-4-92-78-95
Elyssar, Saadjiyan Building	
Oman (Sultanate of)	
Capital Store L.L.C.	☎968-2-4561888
Muttrah High Street P.O. Box 570 Muscat	
Qatar	
○ Salam Studio & Stores	☎974-4-83-20-50
P.B. No. 121, West Bay, Doha	
○ Salam Studio & Stores	☎974-4-42-51-48
P.B. No. 121, Sadd Street, Doha	
Saudi Arabia	
Shaman Stores	☎966-1-463-14-76/85
P.O. Box 1810, Riyadh 11441	
Shaman Stores	☎966-2-644-24-73
P.O. Box 3578, Jeddah 21481	
Shaman Stores	☎966-2-864-11-31
P.O. Box 1353, Khobar 31952	
United Arab Emirates	
○ Salam Studio & Stores L.L.C.	☎971-4-324-52-52
P.O. Box 4199, Dubai	
○ Salam Studio & Stores	☎971-2-79-20-00
P.O. Box 417, Abu-Dhabi	
○ Salam Studio & Stores Center	☎971-4-69-34-30
P.O. Box 4199, Dubai	
○ Salam Studio & Stores	☎971-3-64-15-14
P.O. Box 1342, Al-Ain	
Yemen	
Al - Haidary for Trading	☎967-1-27-18-93/23-37
Gamal A. Nasser Street, Sanaa, P.O. Box 2942	

AFRICA

Ethiopia	
Sunderji Kalidas & Son's (ETH) Plc.	☎251-1-55-36-90
P.O. Box 1243, Aduwa Road, Wereda 2, Kebelle 10, House No. 565, Addis Ababa	
Mauritius	
Era Photo Cine House Ltd.	☎230-212-01-71
6 Edith Cavell Street, Port-Louis	
South Africa	
○ ISO PHOTO Div. New Teltron (Pty) Ltd., JHB	☎27-11-9910600
Building 5, Clearwater Office Park, Cnr Christiaan De Wet & Millenium Boulevard, Rodepoort, JHB South Africa	
○ ISO PHOTO Div. New Teltron (Pty) Ltd., Cape Town	☎27-21-550-1411
20 Bolt Avenue, Montague Gardens, Cape Town, 7441	
○ ISO PHOTO Div. New Teltron (Pty) Ltd., Port Elizabeth	☎27-41-374-4401
48 York Road, North End, Port Elizabeth, 6001	
○ ISO PHOTO Div. New Teltron (Pty) Ltd., Durban	☎27-31-705-0650
Unit 1 Chelsea Road Industrial Park, 1 Blasé Road, New Germany Durban, 3610	
○ Camera Tek CC (PENTAX Workshop)	☎27-11-2512400
Unit E3, Strijdom Commercial Park, Tungsten Road, Strijdom Park, JHB South Africa	

OCEANIA

Australia	E-mail: sales@crkennedy.com.au
○ C. R. Kennedy & Company Pty. Ltd.	☎61-3-9823-1555
663 - 669 Chapel Street, South Yarra, Melbourne, Victoria 3141	
○ C. R. Kennedy & Company Pty. Ltd.	☎61-2-9552-8300
Level 3, 280 Coward Street, Mascot, Sydney, New South Wales 2020	
○ C. R. Kennedy & Company Pty. Ltd.	☎61-7-3862-6222
80 Kingsford Smith Drive Albion, Brisbane, Queensland 4010	
○ C. R. Kennedy & Company Pty. Ltd.	☎61-8-8410-0533
261 Sturt Street Adelaide, South Australia 5000	
○ C. R. Kennedy & Company Pty. Ltd.	☎61-8-9381-7144
17-19 Oxford Close, West Leederville, Perth, Western Australia 6007	
New Zealand	
Ian R. Little Ltd.	☎64-3-360-2550
Airport Business Park, 14 Mcleans Island Road, P.O. Box 1287, Christchurch	
E-mail: irli@irli.co.nz	
Fiji Islands	
Motibhai and Company Limited	☎679-6722477
Motibhai Building, 1 Industrial Road, PO Box 9175, Nadi Airport	
E-mail: service@motibhai.com.fj	