

RCL meter

PM 6303

9452 063 03001

Operating manual

9499 520 08201

84 04 01/2 / 01-03

S&I

Scientific & Industrial Equipment Division



PHILIPS

Positive feedback

Now you are the user of a Philips test and measuring instrument. We trust that it will give you many years of faithful service. But we would like you to realize one thing: we can only supply the best in T & M equipment with **your** help, user.

We need to know what you have found to be the strong and weak points of this instrument; and we would be very interested to hear about any unusual or elegant applications you have devised for it. Some of this information can be passed on to our design and development departments; and some may be fed back to other users via our bimonthly publication **T & M News**.

May we therefore suggest that you fill in the reply card alongside and send it back to us right now. That way, you'll be helping to provide the positive feedback we need to help you!

All contributions that are published will be paid for at current rates; while as an inducement for you to fill in the reply card, we are offering a free subscription to T & M News or a free copy of Part I of our Digital Instrument Course to all who reply.

Erfahrungsaustausch

Meßgeräte müssen sich in der Praxis bewähren und die in sie gesteckten Erwartungen erfüllen; auch bei Ihnen, dem Besitzer eines Geräts aus der Serie der Philips Test- und Meßgeräte. Wir aber können T & M-Geräte nur zu Ihrer vollen Zufriedenheit herstellen, wenn wir alle Ihre Wünsche kennen.

Deshalb interessiert uns Ihre Meinung über die guten und weniger guten Eigenschaften dieses Gerätes. Außerdem suchen wir Erfahrungen über ungewöhnliche oder neue Anwendungsmöglichkeiten. Vielleicht können Sie unseren Entwicklungs- und Konstruktionsabteilungen einen guten Wink geben; vielleicht können wir Ihre Erfahrungen aber auch in unserer Publikation **Info-dienst** (nur in Deutschland) veröffentlichen, damit auch andere Anwender davon profitieren können.

Deshalb möchten wir Sie bitten, die anhängende Antwortkarte auszufüllen und an uns zurückzusenden. Damit helfen Sie uns, und wir können Ihnen helfen!

Alle veröffentlichten Beiträge werden dem üblichen Tarif entsprechend honoriert. Als Dank für das Ausfüllen der Antwortkarte bieten wir Ihnen ein Freiabonnement auf Info-dienst (nur in Deutschland) oder ein kostenloses Exemplar von Teil I von unserem Kursus Digital Instrument.

L'intérêt du "feedback"

Vous voilà possesseur d'un instrument d'essai et de mesure Philips. Nous espérons qu'il vous donnera de nombreuses années de bons et loyaux services, mais nous voudrions attirer votre attention sur un point: ce n'est qu'avec **votre** aide que nous pouvons fournir des matériels d'essai et de mesure de toute première qualité.

Nous avons besoin de savoir quels en sont les points forts et les points faibles que vous avez découverts et nous serions très intéressés d'apprendre quelles applications inhabituelles ou élégantes vous lui avez trouvé. Certains de ces renseignements peuvent être transmis utilement à nos bureaux d'études; certains autres peuvent être communiqués à d'autres utilisateurs par l'intermédiaire de notre publication **T & M Informations** (édition française seulement en France).

C'est pourquoi nous vous serions reconnaissants de remplir la carte-réponse à côté et de nous la renvoyer. De cette façon, vous contribuerez à nous fournir le "feedback" dont nous avons besoin pour mieux vous servir!

Toutes les réponses publiées seront payées conformément aux tarifs en vigueur; pour vous inciter à remplir la carte-réponse, nous offrons un abonnement gratuit à T & M Informations ou un exemplaire gratuit de la première partie de notre cours sur les instruments numériques à tous ceux qui répondront.

Details of user:

Persönliche Angaben:

Expéditeur:

Company/
Firma/Société.....
Department/
Abteilung/Service.....
Street/Straße/Rue.....
Box/Postfach/Boîte Postale.....
City/Stadt/Ville.....
Country/Land/Pays.....
Name/Name/Nom.....
Phone/Telefon/Numéro de téléphone.....

Details of instruments:

Gerätedaten:

Instrument:

Name/Name/
Désignation.....
Type number/Typennummer/
Numéro de type.....
Serial number/Seriennummer/
Numéro de série.....
Date purchased/Kaufdatum/
Date d'achat.....

What are the main applications for which you use this instrument?
Wofür verwenden Sie dieses Gerät hauptsächlich?
Quelles sont les principales utilisations auxquelles vous affectez cet instrument?

Please, list what you consider to be the **strong points** and the **weak points** of the instrument. Zählen Sie bitte auf, was Ihrer Meinung nach die **guten Seiten** und was die **schwachen Stellen** dieses Geräts sind. Veuillez énumérer ce que vous considérez être les **points forts** et les **points faibles** de l'instrument.

Do you have any queries about the use of this instrument? If so, what?

Haben Sie irgendwelche Fragen über die Anwendung dieses Geräts? Wenn ja, welche?

Avez-vous des questions à poser sur l'emploi de l'instrument?

Si oui, lesquelles?

I have devised an interesting application for this instrument.

- I enclose a brief description (up to about 500 words) of this application
 Please send a representative to collect information about the application

Ich habe einen interessanten Verwendungszweck für dieses Gerät gefunden.

- Eine kurze Beschreibung hiervon (max. ca. 500 Wörter) erhalten Sie anliegend.
 Senden Sie bitte jemanden, der sich an Ort und Stelle über den Verwendungszweck informieren kann.

J'ai trouvé une application intéressante pour cet instrument

- Je joins une brève description (500 mots environ au maximum) de cette application.
 Veuillez envoyer un représentant à qui nous donnerons des renseignements sur l'application.

- I would like to receive **T & M News** regularly.
 Please send me Digital Instrument Course Part I.
 Ich möchte **Info-dienst** regelmäßig beziehen.
 Senden Sie mir Digital Instrument Course, Teil I.
 J'aimerais recevoir **T & M Informations** régulièrement.
 Envoyez moi la première partie du cours sur les instruments numériques.



PHILIPS

T & M News
N.V. PHILIPS' GLOEILAMPENFABRIEKEN
S & I TQ III - 4
Test and Measuring Instruments Department
Att. Mr. T. Sudar
EINDHOVEN
The Netherlands

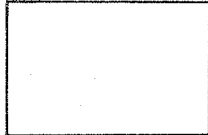

please fold

T & M News is your feedback unit

T & M News is a bimonthly publication issued by the T & M Measuring Department of Philips' Science & Industry Division, for distribution to actual and potential users of Philips' T & M equipment. It provides an effective means of exchanging information in the T & M field - both from the manufacturer to the customer and vice versa.

Apart from T & M News itself, we also issue T & M Reports, which provide a vehicle for (generally longer) articles of a more specialized and/or theoretical nature to supplement the information given in T & M News. These Reports, being of a more specialized interest, are generally sent to a more restricted group of users; though anyone who is interested can obtain them on request.

One special series that was brought out in supplements to T & M News is our Digital Instrument Course (Part I: Basic binary theory and logic circuits; Part II: Digital counters and timers; Part III: Digital voltmeters and multimeters; Part IV: IEC Bus Interface), which proved so popular with readers that each part of the course has been issued in booklet form.

Info-dienst für Ihren Erfahrungsaustausch

Info-dienst (nur in Deutschland) ist eine Publikation der Philips GmbH Unternehmensbereich für Elektronik für Wissenschaft und Industrie für die jetzigen Besitzer und potentiellen Kunden von Philips T & M-Geräten. Dieses Blatt strebt einen effektiven Informationsaustausch auf dem T & M-Gebiet zwischen Hersteller und Anwender sowie umgekehrt an.

Neben diesen Info-dienst geben wir auch die T & M Reports heraus (nur in englischer Sprache), in denen (im allgemeinen längere) Artikel mehr spezieller bzw. theoretischer Art als Ergänzung zu den Informationen in Info-dienst stehen. Diese Reports, an denen in allgemeinen nur Spezialisten interessiert sind, werden an eine begrenzte Anwendergruppe verteilt. Jeder, der daran interessiert ist, kann sie auf Anfrage erhalten.

Eine spezielle Serie, die gerade in den T & M News Supplements erschienen ist, war unser Digital Instrument Course (Teil I: Basic binary theory and logic circuits; Teil II: Digital counters and timers; Teil III: Digital voltmeters and multimeters; Teil IV: IEC Bus Interface). Diese Serie war bei den Lesern so populär, daß jeder Teil von diesem Kursus auch in Buchform herausgegeben wurde (nur in englischer Sprache).

T & M Informations est notre moyen de communiquer mutuellement

T & M Informations est une publication de département de Mesure de Philips, destinée aux utilisateurs effectifs et un puissance d'appareils d'essai et de mesure Philips. Elle constitue un moyen efficace de transmettre de l'information dans ce domaine, aussi bien du fabricant vers le client que vice versa.

A part la publication T & M Informations proprement dite, nous diffusons les T & M Reports (seulement en anglais) qui contiennent des articles (généralement plus longs) de nature plus spécialisée ou plus théorique, destinés à compléter l'information donnée dans T & M Informations. Etant donné leur nature, ces Reports ne sont généralement envoyés qu'à un cercle plus restreint d'utilisateurs; toutefois, quiconque s'y intéresse peut les obtenir sur demande.

Nous venons de publier dans les T & M News Supplements une série spéciale d'articles qui constituent un cours sur les instruments numériques (1ère partie: Théorie binaire de base et circuits logiques; 2ème partie: Compteurs numériques et minuteries; 3ème partie: voltmètres et multimètres numériques; 4ème partie: IEC Bus Interface) qui a rencontré un tel succès auprès des lecteurs que chaque partie du cours a été réimprimée sous forme de livret (seulement en anglais).



APPENDIX 1:
Algorithms used in PM 6303;
Phasor Diagrams of Various CUT Types

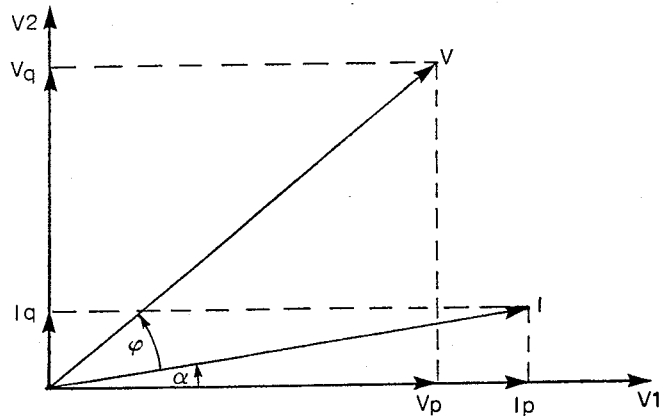

Definitions:

- V: CUT voltage
- I: CUT current
- V1, V2: switching voltages of the phase-sensitive rectifier

The phase angle between I and V is φ .
 The phase angle between I and V1 is α .

In the diagram the phase relation between I and V is related to a lossy inductance.

In each measuring cycle the following components are determined: V_p, V_q, I_p, I_q .

From these components the series resistance and reactance of the CUT are calculated by the processor:

$$R_s = \frac{V_p I_p + V_q I_q}{I_p^2 + I_q^2} \quad (1)$$

$$X_s = \frac{V_q I_p - V_p I_q}{I_p^2 + I_q^2} \quad (2)$$

These formulas can be derived from:

$$I^2 = I_p^2 + I_q^2$$

$$R_s = \frac{V}{I} \cos \varphi = \frac{V}{I} [\cos (a + \varphi) \cos a + \sin (a + \varphi) \sin \varphi]$$

$$= \frac{V}{I} \cdot \frac{V_p I_p + V_q I_q}{V I} = \frac{V_p I_p + V_q I_q}{I^2}$$

$$X_s = \frac{V}{I} \sin \varphi = \frac{V}{I} [\sin (a + \varphi) \cos a - \cos (a + \varphi) \sin a]$$

$$= \frac{V}{I} \cdot \frac{V_q I_p - V_p I_q}{V I} = \frac{V_q I_p - V_p I_q}{I^2}$$

Note that a has no influence in the formulas for R_s, X_s . a is assumed to be constant during one measurement cycle.

The following is valid:

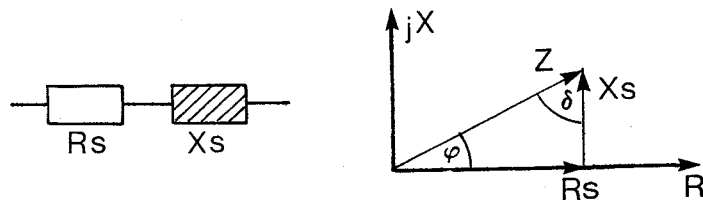

$$\varphi = 90^\circ - \delta$$

quality factor

$$Q = \tan \varphi = 1/D = \frac{|X_s|}{R_s} \quad (3)$$

dissipation (loss) factor

$$D = \tan \delta = 1/Q = \frac{R_s}{|X_s|} \quad (4)$$

The magnitude of Q and the signum of X_s determine which parameter of the CUT is calculated and displayed in the "RCL AUTO" mode. The calculation formulas for the various parameters of the front-panel menu are:

Q as given by equation (3)

$$D = \frac{1}{Q}$$

$$R_p = (1 + Q^2) R_s$$

R_s as given by equation (1)

$$Z = \sqrt{R_s^2 + X_s^2}$$

$$C_p = \frac{1}{\omega (1 + 1/Q^2) X_s} \quad \text{if } X_s < 0$$

$$L_p = \frac{(1 + 1/Q^2) X_s}{\omega} \quad \text{if } X_s > 0$$

$$C_s = \frac{1}{\omega |X_s|} \quad \text{if } X_s < 0$$

$$L_s = \frac{|X_s|}{\omega} \quad \text{if } X_s > 0$$

Impedance
Admittance

$$\begin{aligned} Z &= R + jX \\ Y &= 1/Z = G + jB \\ G &= R/(R^2 + X^2) \\ B &= -X/(R^2 + X^2) \end{aligned}$$

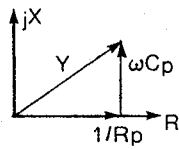
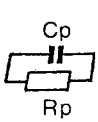

$$Y = \frac{1}{R_p} + j\omega C_p \quad D = \frac{1}{\omega C_p R_p} \quad C_s = (1 + D^2) \cdot C_p \quad R_s = \frac{D^2}{1 + D^2} \cdot R_p$$

$$Z = \frac{R_p (1 - j\omega C_p R_p)}{1 + (\omega C_p R_p)^2}$$

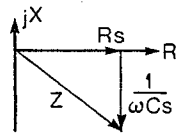
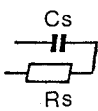

$$Z = R_s - j \frac{1}{\omega C_s} \quad D = \omega C_s R_s \quad C_p = \frac{1}{1 + D^2} \cdot C_s \quad R_p = \frac{1 + D^2}{D^2} \cdot R_s$$

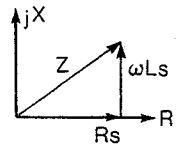
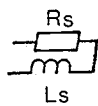

$$Z = R_s + j\omega L_s \quad D = \frac{R_s}{\omega L_s} \quad L_p = (1 + D^2) \cdot L_s \quad R_p = \frac{1 + D^2}{D^2} \cdot R_s$$

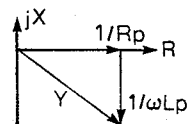
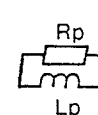

$$Y = \frac{1}{R_p} - j \frac{1}{\omega L_p} \quad D = \frac{\omega L_p}{R_p} \quad L_s = \frac{1}{1 + D^2} \cdot L_p \quad R_s = \frac{D^2}{1 + D^2} \cdot R_p$$

$$Z = \frac{R_p (1 + jR_p/\omega L_p)}{1 + (R_p/\omega L_p)^2}$$

1. GENERAL

1.1. INTRODUCTION

The **PM 6303 RCL meter** is used for measurements of resistances, capacitances and inductances. Providing auto-function and auto-ranging facility the instrument allows fast and high precision measurements of passive components over a wide range.

The component under test is directly connected to the instrument, either via a two-terminal test fixture, a four-wire test cable or a four-terminal test adapter. The measurement result, namely numerical value, dimension and the equivalent-circuit symbol, is immediately displayed on a large 4-digit liquid-crystal display (LCD), updated at a rate of two measurements per second.

A microprocessor controls the measurement process, computes the measurement value and transfers the result to the display.

In the RCL AUTO mode the dominant component, either R, C or L of the component under test is automatically selected for display. RCL AUTO is also the default mode of the instrument after power-on.

For an inductance e.g. with quality factor $500 > Q > 1$ the instrument indicates the measurement value of the series inductance and as equivalent-circuit symbol the series connection of a resistance and an inductance.

In addition to the RCL AUTO mode with display of the dominating component 8 further parameters can be selected by 2 pushbuttons providing a stepping function, whereby the appropriate parameter is marked by a LED:

Quality factor Q, dissipation factor D,
parallel resistance R_p, series resistance R_s,
impedance Z,
parallel capacitance C_p or parallel inductance L_p,
series capacitance C_s or series inductance L_s,
series capacitance, internally biased C_s (2 V BIAS).

The instrument is especially suited for use in laboratories, for quality control, service workshops and for education purposes.

1.2. CHARACTERISTICS

1.2.1. Safety characteristics

This apparatus has been designed and tested in accordance with Safety Class I requirements of IEC Publication 348, Safety Requirements for Electronic Measuring Apparatus, and has been supplied in a safe condition. This manual contains some information and warnings which must be followed by the user to ensure safe operation and to retain the apparatus in a safe condition.

1.2.2. Performance characteristics, specifications

Properties expressed in numerical values with stated tolerance are guaranteed by the manufacturer. Specified non-tolerance numerical values indicate those that could be nominally expected from the mean of a range of identical instruments.

This specification is valid after the instrument has warmed up for 5 minutes (reference temperature 23°C).

If not stated otherwise, relative or absolute tolerances relate to the set value.

designation

9 parameters

3 pushbuttons for parameter selection

display

measuring value

11 dimension indications

7 equivalent-circuit symbols

specification

RCL AUTO

Q

D

Rp

Rs

Z

Cp or Lp

Cs or Ls

Cs (2 V BIAS)

1 reset button

2 step buttons

4 digits

Ω , k Ω , M Ω

pF, nF, μ F, mF

μ H, mH, H, kH

additional information

for RCL AUTO the dominant component R, C or L is automatically determined, see Fig. 1

internal bias voltage for capacitors

RCL AUTO

for selection of required parameter: stepping from parameter to parameter; continuous stepping when button is kept pushed

Liquid-crystal display (LCD)

7-segment, 18 mm high

parameter	condition
RCL AUTO, Rp, Rs, Z, Q	} $D > 500$
RCL AUTO, Z, D, Cp, Cs, Cs (2 V BIAS)	
RCL AUTO, Ls, Lp, Z, D	} $Q > 500$
RCL AUTO, Cs, Rs, Cs (2 V BIAS)	
RCL AUTO, Ls, Rs, Q, D, Z	} $500 > Q > 0,002$ $0,002 < D < 500$
Lp, Rp	

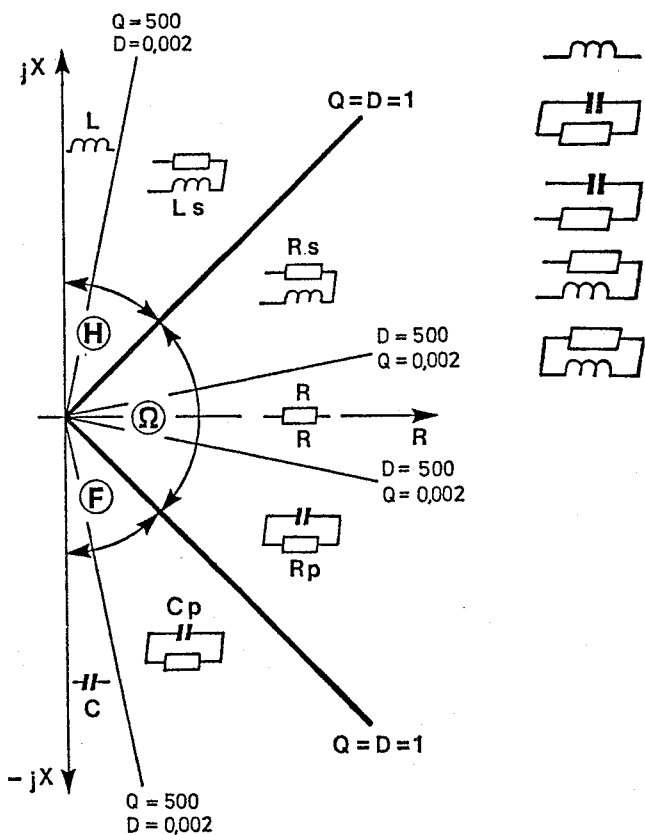

Fig. 1

Equivalent-circuit symbol and dominating parameter in the sectors of the phasor plane (RCL AUTO)

designation specification additional information

measuring ranges.

- resistance	0.000 Ω - 200 M Ω	Rp, Rs, Z
- capacitance	0.0 pF - 100 mF	Cp, Cs
- inductance	0.0 μ H - 32 kH	Lp, Ls
- quality factor	0.002 - 500	Q
- dissipation factor	0.002 - 500	D

max. resolution

- resistance	1 m Ω
- capacitance	0.1 pF
- inductance	0.1 μ H
- quality factor	0.001
- dissipation factor	0.001

measuring accuracy:

basic error $\pm 0.25\% \pm 1$ digit } of display reading,
 additional error } see Fig. 2, 3, 4

measuring range for basic error see Fig. 2

- resistance	0.4 Ω ... 4 M Ω	D > 10
- capacitance	40 pF ... 400 μ F	Q > 10
- inductance	60 μ H ... 600 H	Q > 10
- quality factor	0.3 ... 3,0	
- dissipation factor	0.3 ... 3,0	

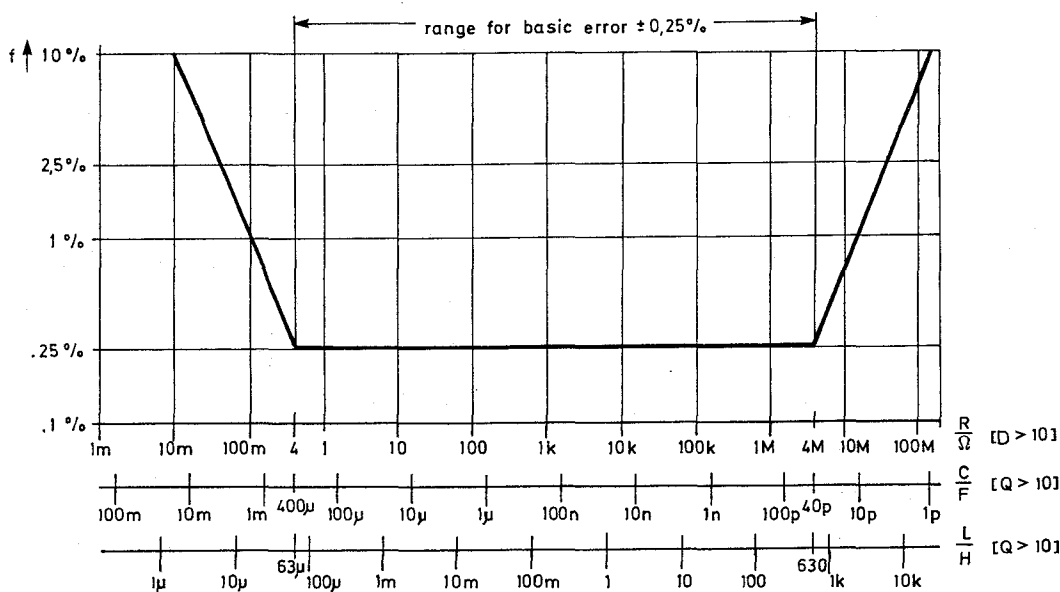

Fig. 2 Measurement error

designation

specification

additional information

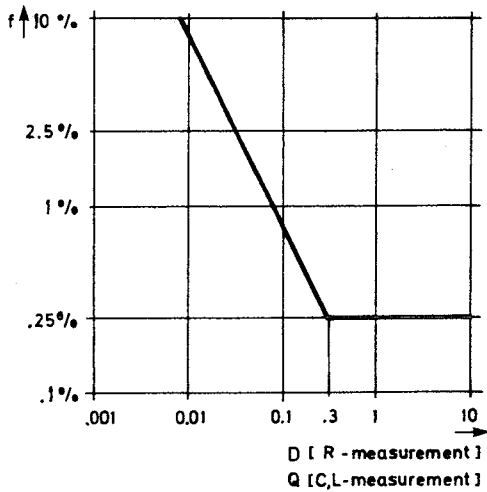

Fig. 3 Error limits versus Q and D

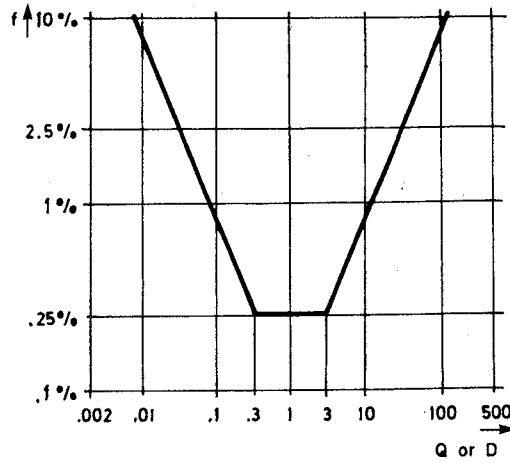

Fig. 4 Error limits for Q and D

overrange indication

flashing of the four digits center segments

- $R > 200 \text{ M}\Omega$
- $C > 100 \text{ mF}$
- $L > 32 \text{ kH}$
- $Q > 500$
- $D > 500$
- for $Q, D > 500$ flashing for parameter selection deviating from displayed equivalent-circuit symbol
- for C_s (2 V Bias), if $Q < 0.1$ or if inductance is identified

connection of component

- for meas. voltage (HI)
- for meas. current (LO)
- for measuring earth

two 4 mm sockets
two 4 mm sockets
one 4 mm socket

SENSE and DRIVE (-BIAS) connection
SENSE and DRIVE (+BIAS) connection
GUARD

max. ext. voltage

$\pm 5 \text{ Vdc}$

between GUARD and all other socket,
between HI and LO

max. component load

2 V, 5 mA

voltage source with 2 V open-circuit
voltage and 400Ω int. resistance

measuring frequency
– tolerance

1 kHz
 $\pm 0.025 \%$

measurement update rate

approx. 2 meas./s

compensation of zero-capacitance

Co TRIM

by screwdriver, on front panel

– max. comp. capacitance

5 pF

1.2.3. Power supply

ac mains

reference value	220 V
nominal values	110 V/128 V/220 V/238 V, selectable by solder links
nominal operating range	±10 % of selected nominal value
operating limits	±10 % of selected nominal value
nominal frequency range	50 - 100 Hz
limit range of operation	47.5 - 105 Hz
power consumption	13 W

1.2.4. Environmental capabilities

The following environmental data are valid only if the instrument is checked in accordance with the official checking procedure. Details on these procedures and failure criteria are supplied on request by the PHILIPS organization in your country or by PHILIPS INTERNATIONAL B.V., SCIENTIFIC & INDUSTRIAL EQUIPMENT DIVISION, EINDHOVEN, THE NETHERLANDS.

Ambient temperature:

reference value	+23 °C ±1 K
nominal working range	+ 5 °C ... +40 °C
limit range of operation	+ 5 °C ... +40 °C
limits for storage and transport	-40 °C ... +70 °C

Relative humidity:

reference range	45 ... 75 %
nominal working range	20 ... 80 %
limit range of operation	10 ... 85 %
limits for storage and transport	0 ... 85 %

Air pressure:

reference value	1013 mbar (≅ 760 mm Hg)
nominal working range	800 ... 1066 mbar (≅ 600 ... 800 mm Hg, up to 2200 m height)

Air speed:

reference value	0 ... 0.2 m/s
nominal working range	0 ... 0.5 m/s

Heat radiation:

direct sunlight radiation not allowed

Vibration:

limits for storage and transport	max. 0.35 mm amplitude (10 to 60 Hz)
	max. 5 g (60 to 150 Hz)

radio interference voltage

level of interference < K

operating position

normally upright on feet or with handle fold down

warm-up time

5 min

1.2.5. Cabinet

protection type (see DIN 40 050)	IP 20
protection class (see IEC 348)	class I, protective conductor
line connection	mains cable, fixed to the instrument
overall dimensions:	
height	140 mm
width	310 mm
depth	310 mm
weight	4.8 kg (11 lbs)

1.3. ACCESSORIES

1.3.1. Standard accessories

operating manual	9499 520 08201
fuse	250 mA
2-terminal test fixture	5322 265 24026, Fig. 32
	By means of the 2-terminal test fixture common components are connected

1.3.2. Optional accessories

service manual	9499 525 00911
4-wire test cable	PM 9541, Fig. 33
RCL adapter with 2 single test posts and 1 double test post	PM 9542, Fig. 34

For precise results low-ohmic impedances $< 100 \Omega$ should be measured applying 4-wire system. For this the 4-wire test cable with Kelvin clamps PM 9541 and the RCL adapter PM 9542 are available. PM 9541 is also ideal for in-circuit testing of components. PM 9542 is designed to provide rapid low impedance connection to the instrument, whatever the shape and dimension of the component under test.

Please remove the two single test posts, if you use the double test post for CUT connection or remove the double test post if you use the two single test posts.

Wrong insertion of the plug into the RCL meter is prevented by unsymmetrical arrangement of the pins.

About compensation of the zero capacitance chapter 3.4.3 gives some information.

When measuring low-ohmic components with PM 9541, the short-circuit inductance of max. $0.3 \mu\text{H}$ of the cable must be taken into account.

For understanding the measurement circuit when applying the accessories, see figs. 32-34.

Performance characteristics	PM 9541	PM 9542
CUT connection	2 Kelvin clips	Kelvin contacts within the test posts
short-circuit inductance	$0.1 \mu\text{H}$, max. $0.3 \mu\text{H}$	$< 0.1 \mu\text{H}$
measuring accuracy with PM 6303	as for PM 6303, but additional error for very low-ohmic CUTs caused by the internal short-circuit inductance	as for PM 6303
environmental capabilities	as for PM 6303, as far as applicable	as for PM 6303, as far as applicable
mechanical specifications		
— cable length	0.6 m	0.6 m
— dimension		50 mm x 145 mm x 95 mm
— weight	0.2 kg	0.6 kg

1.4. OPERATING PRINCIPLE

1.4.1. Description of the block diagram, Fig. 30

The 16 MHz crystal clock generates the basic frequency for all signals, so the count pulses for the analog to digital converter ADC.

The frequency divider generates the 8 MHz clock pulse for the microprocessor and the 1 kHz test frequency in 3 reference phases, namely 0° , 90° and 180° .

In the phase selector the CPU selects the appropriate reference phase 0° , 90° or 180° for the phase sensitive rectifier and the ADC.

The band-pass filter 1 converts the TTL signal into a 1 kHz sine wave signal.

The test voltage amplifier amplifies the 1 kHz sine wave signal to a 2 V_{eff} open circuit voltage at the component under test (CUT) connection. In the 'Cs biased' mode 2 V_{dc} are added to the 1 kHz signal.

The isolating buffer senses the voltage at the CUT.

The inverting amplifier feeds a compensating current via capacitor C (90° phase shift) into the current to voltage converter input for equalizing the stray capacitances. The amplitude of the compensating current is set by Co TRIM.

The current to voltage converter converts the current through the CUT into a proportional voltage. The conversion factor can be switched by a factor of 10.

For current or voltage measurement the input of the subsequent differential amplifier is switched over by the voltage/current (V/I) selector controlled by the CPU.

In the programmable amplifier gain factors x0.1, x1 or x10 are selected by the CPU depending on the impedance of the CUT. For the reference measurement the input is short-circuited.

The 1 kHz band-pass filter 2 suppresses hum interference and reduces the harmonic components of the 1 kHz measurement signal.

The level detector compares the output voltage of band filter 2 with a preset reference value. If this value is exceeded, the CPU switches the programmable amplifier to a lower gain factor.

The phase sensitive rectifier generates dc voltages which are proportional to that component of the measuring voltage being in-phase with the reference voltage.

The analog to digital converter ADC converts the output signal of the rectifier into a binary number which can be processed by the CPU.

The central processing unit CPU with the inherent microprocessor controls and monitors the measurement process, computes and stores the measurement values and transfers the result to the display.

The LCD control transforms the serial data transmitted by the CPU into parallel data and controls the liquid-crystal display which operates in duplex mode.

In the LED control the parameter key actuations are verified and processed. The selected parameter is indicated by a LED. Simultaneously the information is BCD-coded and sent to the CPU, whereby the most significant bit directly switches on the 2 V_{dc} voltage, when the parameter Cs (2 V Bias) is set.

The power supply generates the required stabilized dc voltages +15 V, -15 V and +5 V for the circuitries.

1.4.2. Measuring principle

The **measurement principle** is based on the so-called **current and voltage measurement technique**: the component voltage and after that the component current are measured. The measured values are converted to binary numbers. From these numbers the CPU computes the CUT parameter of interest. According to the front panel parameter selection, either the dominating component —resistance, capacitance or inductance— or one of the other selectable parameters is displayed.

Each measurement cycle lasts approx. 0.5 s. It comprises **5 single measurements**, the results of which are stored in the microprocessor data memory, a subsequent arithmetic evaluation and a final transfer of the result to the display. The 5 single measurements are as follows:

1. Reference measurement:

At the beginning of each measurement cycle a reference measurement is performed, whereby the input of the programmable amplifier is short-circuited. The counter contents of the A/D conversion at the end of this measurement serves as reference for the subsequent 4 measurements.

2. 0° voltage measurement:

The voltage at the CUT is measured.

The switching phase of the phase sensitive rectifier is 0° .

3. 90° voltage measurement:

The voltage at the CUT is measured.

The switching phase of the phase sensitive rectifier is 90° .

4. 0° current measurement:

The inputs of the differential amplifier are switched over to the output of the current to voltage converter.

The current through the CUT is measured.

The switching phase of the phase sensitive rectifier is 0° .

5. 90° current measurement:

The current through the CUT is measured.

The switching phase of the phase sensitive rectifier is 90° .

At the end of the 5 single measurements the 5 corresponding binary numbers of the A/D conversions and the assigned gain factors are stored in the microprocessor data memory. From this the microprocessor first calculates the equivalent series resistance R_s , the equivalent series reactance X_s and the quality factor $Q = X_s/R_s$ of the CUT. In the RCL AUTO mode the microprocessor determines the dominant component, either R_s resp. R_p , C_p or L_s , calculates its value, dimension and equivalent-circuit symbol by arithmetic routines and transfers the result to the display. If one of the 8 other parameters is selected by the step keys this parameter is calculated and displayed. After that the microprocessor starts the next measurement cycle with the single measurement routines.

2. INSTALLATION INSTRUCTIONS

2.1. INITIAL INSPECTION

Check the contents of the shipment for completeness and note whether any damage has occurred during transport. If the contents are incomplete, or there is damage, a claim should be filed with the carrier immediately, and the Philips Sales or Service organisation should be notified in order to facilitate the repair or replacement of the instrument.

2.2. SAFETY INSTRUCTIONS

Upon delivery from the factory the instrument complies with the required safety regulations, see para. 1.2.1. To maintain this condition and to ensure safe operation, the instructions below must carefully be followed.

2.2.1. Maintenance and repair

Failure and excessive stress:

If the instrument is suspected of being unsafe, take it out of operation permanently.

This is the case when the instrument

- shows physical damage
- does not function anymore
- is stressed beyond the tolerable limits (e.g. during storage and transportation)

Dismantling the instrument: When removing covers or other parts by means of tools, live parts or terminals could be exposed. Before opening the instrument, disconnect it from all power sources.

If the **open live instrument needs calibration, maintenance or repair**, it must be performed only by trained personnel being aware of the risks. After disconnection from all power sources, the capacitors in the instrument may remain charged for some seconds.

2.2.2. Earthing (grounding)

Before any other connection is made the instrument shall be connected to a protective earth conductor via the three-core mains cable. The mains plug shall be inserted only into a socket outlet provided with a protective earth contact. The protective action shall not be negated by the use of an extension cord without protective conductor.

The **GUARD** connection must not be used to connect a protective conductor.

WARNING: Any interruption of the protective conductor inside or outside the instrument, or disconnection of the protective earth terminal, is likely to make the instrument dangerous. Intentional interruption is prohibited.

2.2.3. **GUARD** connection

The circuit earth potential is applied to the **GUARD** connection and is connected to the cabinet by means of a parallel-connected capacitor and resistor. By this means hum loops are avoided and a clear HF earthing is obtained.

If the circuit earth potential in a measurement set-up is different from the protective earth potential, it must be noticed, that the **GUARD** connection can be touched and that it must not be live, see the safety regulations on the subject (VDE 0411).

3.4. OPERATION AND APPLICATION

3.4.1. Controls and Sockets (Fig. 31)

Legend	Function
POWER	mains switch:
○ ON	white dot for ON position
● OFF	

⊗ RCL AUTO ◁ ◻ RCL AUTO mode: default mode of the instrument after POWER ON

Reset button for RCL AUTO mode, if a different parameter was selected. Numerical value and dimension of the **dominating component** of the component under test is displayed. The appropriate equivalent-circuit symbol is indicated (for details see chapter 3.4.4.)

Display range:

- resistance 0.000 Ω – 200 M Ω
- capacitance 0.0 pF – 100 mF
- inductance 0.0 μ H – 32 kH

equivalent-circuit symbol:

 D > 500

 Q > 500

 Q > 500

 Q resp. D \leq 500

 Q resp. D \leq 500

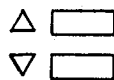

Step buttons for parameter selection.

Continuous stepping in the marked direction, when pushbutton is kept pushed. Selected parameter is indicated by a LED.

Parameters:

⊗ RCL AUTO	diminating component (see above)
⊗ Q	quality factor ($\tan \varphi; Q = 1/D$)
⊗ D	dissipation factor ($\tan \delta; D = 1/Q$)
⊗ Rp	parallel resistance
⊗ Rs	series resistance
⊗ Z	impedance (image impedance)
⊗ Cp or Lp	parallel capacitance/inductance
⊗ Cs or Ls	series capacitance/inductance
⊗ Cs (2 V BIAS)	series capacitance with 2 V internal bias voltage, e.g. for electrolytic capacitors

Legend

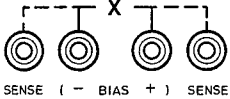
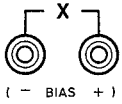
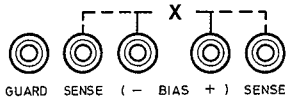

Co TRIM

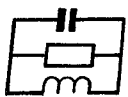

Function

Connections at the frontplate (1 row of 5 sockets)

Connection for component measurement applying 2-wire system

Connection for component measurement applying 4-wire system (recommended for low impedance, < 100 Ω)

measuring earth, screen
(do not shorten to other connectors at the frontplate)

screw driver adjustment for compensation of the zero-capacitance (max. 5 pF). For adjustment see chapter 3.4.3.

Display of the measurement result

max. 4 digits for the numerical value

dimension display:

Ω, kΩ, MΩ
pF, nF, μF, mF; μH, mH, H, kH
no display of dimension for Q and D

equivalent-circuit symbols:

7 different display combinations

Overrange indication:

flashing of the four digits centre segments, when the following limit values are passed:

- resistance > 200 MΩ
- capacitance > 100 mF
- inductance > 32 kH
- quality factor > 500
- dissipation factor > 500

- for Q, D > 500 flashing for parameter selection deviating from displayed equivalent-circuit symbol
- for Cs (2 V Bias), if Q < 0.1 or if inductance is identified

3.4.2. Component Connection

By means of the supplied 2-terminal test fixture common components are connected. For precise results low-ohmic impedances should be measured applying 4-wire system. For this a 4-wire test cable with Kelvin clamps (PM 9541) and the RCL adapter (PM 9542) are optional available.

Furthermore it is possible to connect components to the 4 mm input sockets of the RCL meter via single line cables. When measuring high-ohmic CUTs the zero-capacitance must be considered. If screened cables (single screened wires) are used to reduce additional zero-capacitance the screens must be connected to the GUARD.

ATTENTION: Capacitors with high residual charge (> 5 V) must be discharged before connecting to the measuring input.

3.4.3. Compensation of the Zero-Capacitance

When measuring high-ohmic components the indicated zero-capacitance must be taken into account or compensated by Co TRIM:

- Apply appropriate test fixture or test adapter without CUT to the instrument.
- Select "Cp or Lp" by the step buttons ∇ or Δ .
- Adjust trimmer Co TRIM by screw driver for 0.0 pF display.

On adjustments < 0.0 pF overrange is indicated. If Co TRIM is turned more clockwise an inductance (kH) may be displayed.

3.4.4. RCL AUTO, parameter menu

RCL AUTO is the default mode of the instrument after POWER ON. If necessary, perform compensation of the zero-capacitance by Co TRIM according to chapter 3.4.3.

In this RCL AUTO mode the numerical value and dimension of the dominating component of the CUT are displayed. In addition the appropriate equivalent-circuit symbol is indicated. $Q = D = 1$ is the decision threshold of the RCL meter for defining the dominating component, see Fig. 5. It must be noticed that Q and D are related to the instruments' internal 1 kHz test frequency.

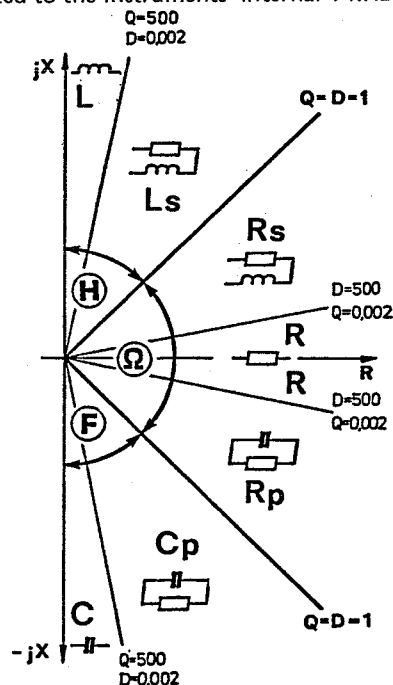

Fig. 5 Displayed equivalent-circuit symbol and dominating component in the various sectors of the CUT impedance phasor plane (RCL AUTO)

In most cases the user will be interested in the dominating component of the CUT, displayed in the RCL AUTO mode. If any other parameter shall be displayed the user may select it from the front panel menu by activating the stepping key ∇ or Δ .

The RCL meter primarily determines the series reactance and resistance of the CUT. From these two quantities the selected CUT parameter is calculated. The algorithm used by the instrument including series/parallel and parallel/series transformation formulas and phasor diagrams of the various CUT types are presented in Fig. 32.

3.4.5. Special user instructions

As pointed out in the preceding chapter in RCL AUTO mode the instrument identifies the dominant component of the CUT and display it. It must be considered that the decision, if the reactive or the ohmic component is dominating, generally depends on the frequency. In PM 6303 an 1 kHz test frequency is applied. This must be taken into account especially if low-ohmic inductors and capacitors or high-ohmic resistors and measured:

Lossy inductors: When testing small lossy inductances often the series loss resistance is identified as dominant component and displayed, because at 1 kHz the series reactance will be very low. Hence, for L_s or L_p display this parameter must be selected from the front-panel menu.

Lossy capacitors with high capacitance, e.g. electrolytic capacitors:

When testing capacitors the user normally will be interested in the value of the capacitance. As the reactance of large capacitors is very low, the series resistance can be dominant resulting in $Q < 1$ and indication of R_p . Hence, for C_s or C_p display these parameters must be selected.

High-ohmic resistors: When testing resistors in the higher $M\Omega$ range the reactance of the parasitic parallel capacitance may be lower than the resistance, resulting in a C_p display. For indication of R_s or R_p these parameters must be selected.

Additional user instructions:

In the C_s (2 V BIAS) mode capacitors can be tested with 2 Vdc bias voltage.

For large capacitors some time is needed for stable display due to the charging process (approx. 0.55/mF).

For the parameter C_s (2 V BIAS) overrange is indicated for $Q < 0.1$ or if an inductance is identified.

The resonant frequency of a larger inductance paralleled by a parasitic capacitance can be below the test frequency. Then, of course, the CUT represents a capacitance at 1 kHz which is displayed.

When testing large inductors especially in the kHz range relative small parasitic parallel capacitances will effect the measurement result. Thus special attention shall be paid on careful C_o compensation.

When testing inductors with ferromagnetic cores normally due to saturation effects the inductance will decrease with higher current or voltage amplitudes. At PM 6303 these amplitudes are resulting from the 2 Vrms open-circuit voltage and the internal 400 Ω resistance of the instrument and the CUT impedance. For lower amplitudes an additional resistor $\geq 71.5 \Omega$ may be connected between GUARD and the centre 4 mm socket (marked with a - sign). For $R_p = 71.5 \Omega$ fig. 6 shows the CUT voltage and current versus impedance relationship. In the shown impedance range the measurement error is increased to about 0.5 % maximum by the load resistor.

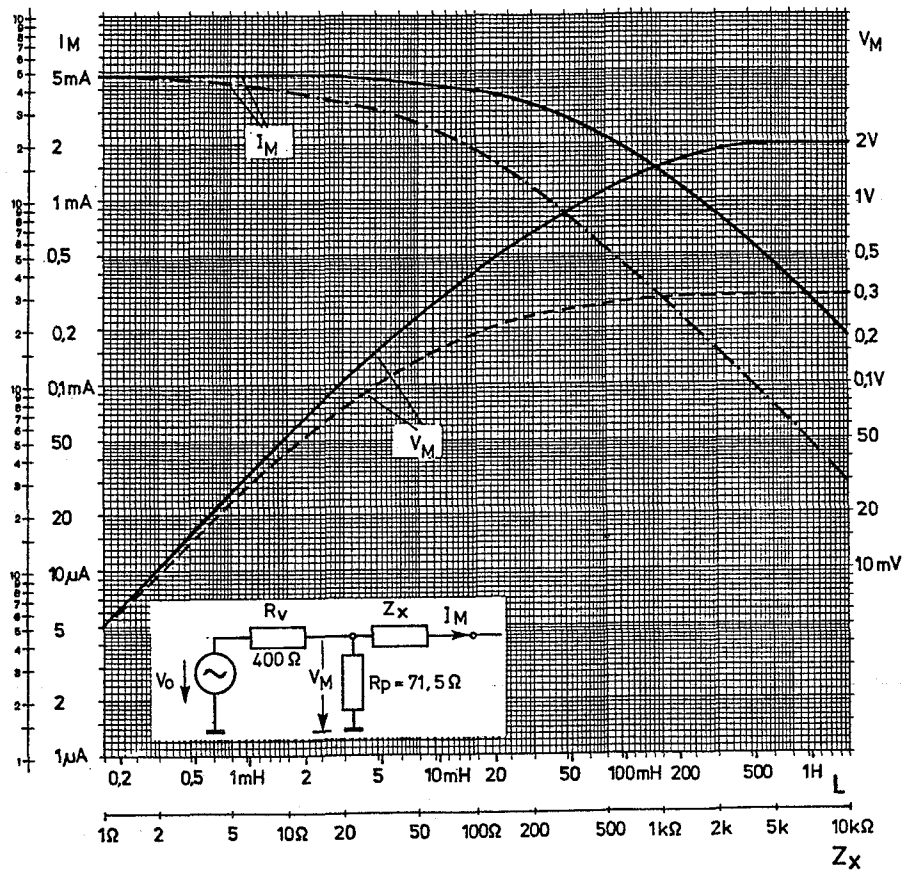

Fig. 6 Measurement voltage and current at an inductive CUT ($Q > 10$, — without R_p , --- with R_p)

3.4.6. Error indication











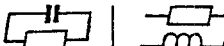
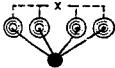

Several functions and logical states of the instrument are continuously internally checked during normal operation. Possible errors are indicated by E0 ... E3 on the display. The meaning of the error codes are given in the following table

Error code	location of malfunction
E0	RAM, microprocessor
E1	progr. amplifier, level detector
E2	counter of ADC, integrator control section
E3	reference measurement circuitry

If an error code is displayed the instrument should be switched off. If after switching on the error code is indicated again please contact the Philips service organisation.

After switching power off a time interval of at least 5 s should pass by -allowing the capacitors of the power supply to discharge- before the device is switched on again. This procedure is necessary to set the internal logic circuitry to its correct initial condition.

6.3. TABLE OF CHECKS AND ADJUSTMENTS

Seq.	parameter mode								measured via point	CUT		display int. measurement	equivalent-circuit symbol	measuring instrument	measured value	adjustment, control pos.	remarks
	RCL AUTO	Q	D	Rp	Rs	Z	Cp or Lp	Cs or Ls		Cs (2 V BIAS)	value						
1.1.									+C					Vdc	+15 ±0.1 V	723	power supply
1.2.									-B					Vdc	-15 ±0.1 V	727	
1.3.									+A					Vdc	+4.75 ... 5.25 V		
2.1.	x								sockets					Vac	1.9 ... 2.1 Vrms	C504	if necessary alter value of capacitor
2.2.	↓								(- and GUARD)					Vdc	< ±20 mV		
2.3.	↓								↓					C/T	999.95 ... 1000.05 μs		
2.4.														Vdc	1.9 ... 2.1 V		
3.1.	x															step-up/step-down, LED control continuous stepping when step button ▼ or ▲ kept pushed for single step press once RESET to RCL AUTO from any parameter mode	
3.2.	x																
3.3.	x																
4.1.	x									open		0.0 pF			Co TRIM	adjust zero-capacitance	
4.2.						x			< 5 mΩ	—	0.000 ... 0.001 Ω					use 4-pole short-circuit adapter	
4.3.	x					x			35 Ω*2	±0.05 %	CUT ±0.25 %						RCL AUTO and Rs same measuring result
4.4.	x								3.5 kΩ	±0.05 %	CUT ±0.25 %						
4.5.	x								35 kΩ	±0.05 %	CUT ±0.25 %						
4.6.	x								350 kΩ	±0.05 %	CUT ±0.25 %						
4.7.	x								3 Ω*2	±0.05 %	CUT ±0.25 %						
4.8.	x								100 MΩ	±1 %	CUT ±6 %						
5.1.	x								10 nF*3	≤ ±0.1 %	CUT ±0.25 %					precision/standard capacitor Q > 1 · 10 ⁴ at 1 kHz overrange indication precision capacitor and resistor in series for defined Q = 4.547 (for calculation of other values see operating manual, appendix 1)	
5.2.		x							10 nF	≤ ±0.1 %	—						
5.3.			x						10 nF	≤ ±0.1 %	0.000						
5.4.							x		10 nF	≤ ±0.1 %	CUT ±0.25 %						
5.5.		x							10 nF 3.5 kΩ	≤ ±0.1 % ±0.05 %	4.53 ... 4.56						

*2 Connect CUT via 4-wire system.

*3 After check of measuring accuracy by precision resistors seq. 4.3. ... 4.8. it is only necessary to control capacitance/inductance measurement by a precision capacitor.
(according to the measuring principle of PM 6303).

7. SAFETY INSPECTION AND TESTS AFTER REPAIR AND MAINTENANCE IN THE PRIMARY CIRCUIT

7.1. GENERAL DIRECTIVES

- Take care that creepage distances and clearances have not been reduced
- Before soldering, wires:
 - should be bent through the holes of solder tags, or wrapped round the tag in the form of an open U, or, wiring rigidity shall be maintained by cable clamps or cable lacing.
- Replace all insulating guards and -plates.

7.2. SAFETY COMPONENTS

Components in the primary circuit may only be renewed by components selected by Philips, see also chapter 8.1.

7.3. CHECKING THE PROTECTIVE EARTH CONNECTION

The correct connection and condition is checked by visual control and by measuring the resistance between the protective-lead connection at the plug and the cabinet/frame. The resistance shall not be more than 0.5 Ω . During measurement the mains cable should be moved. Resistance variations indicate a defect.

7.4. CHECKING THE INSULATION RESISTANCE

Measure the insulation resistance $U = 500$ Vdc between the mains connections and the protective lead connections. For this purpose set the mains switch to ON. The insulation resistance shall not be less than 2 M Ω .

Note:

2 M Ω is a minimum requirement at 40 °C and 95 % relative humidity. Under normal conditions the insulation resistance should be much higher (10 to 20 M Ω).

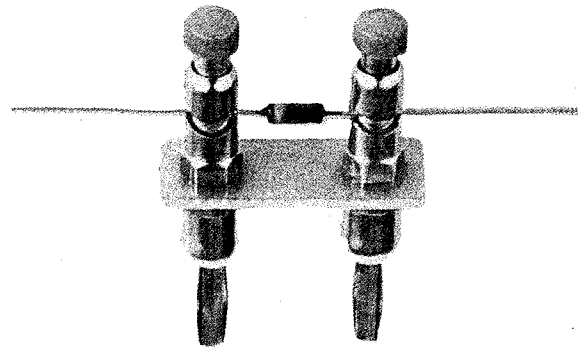
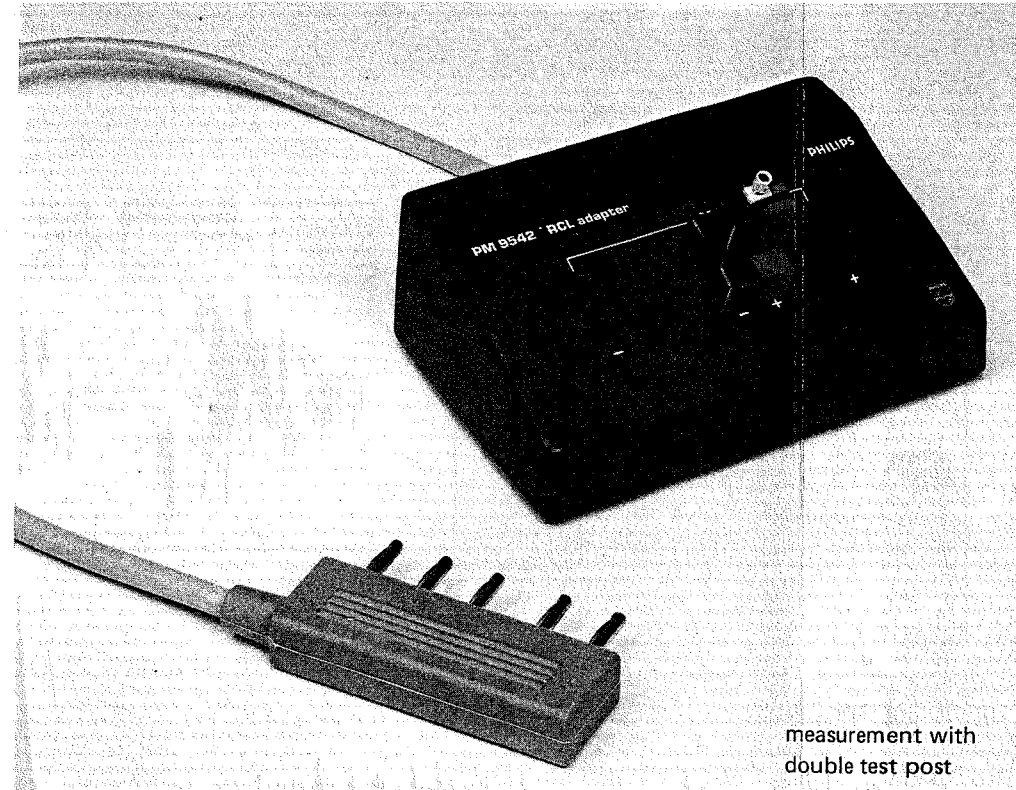
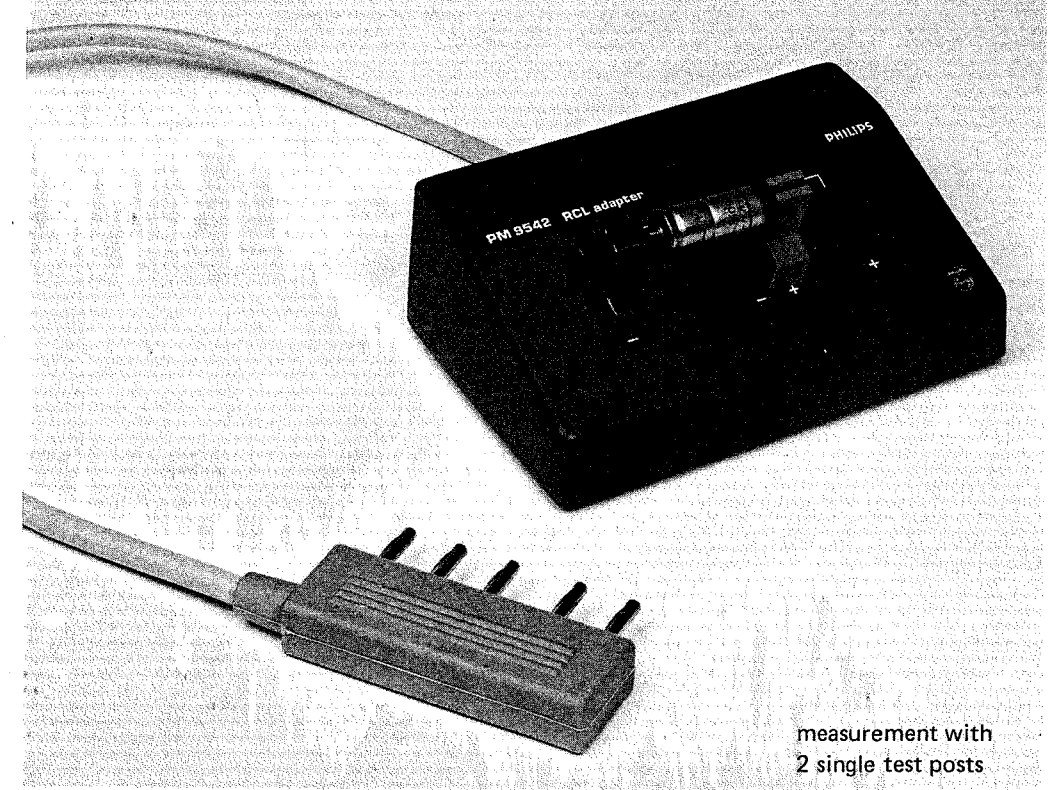

Fig. 32 2-terminal test fixture
2-poliger Testadapter
Adaptateur de test à 2 bornes



measurement with
double test post



measurement with
2 single test posts

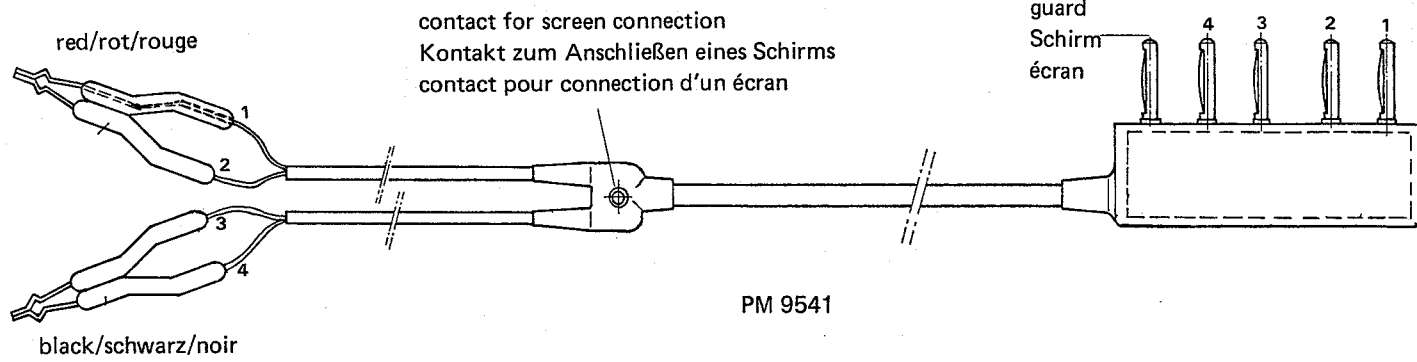
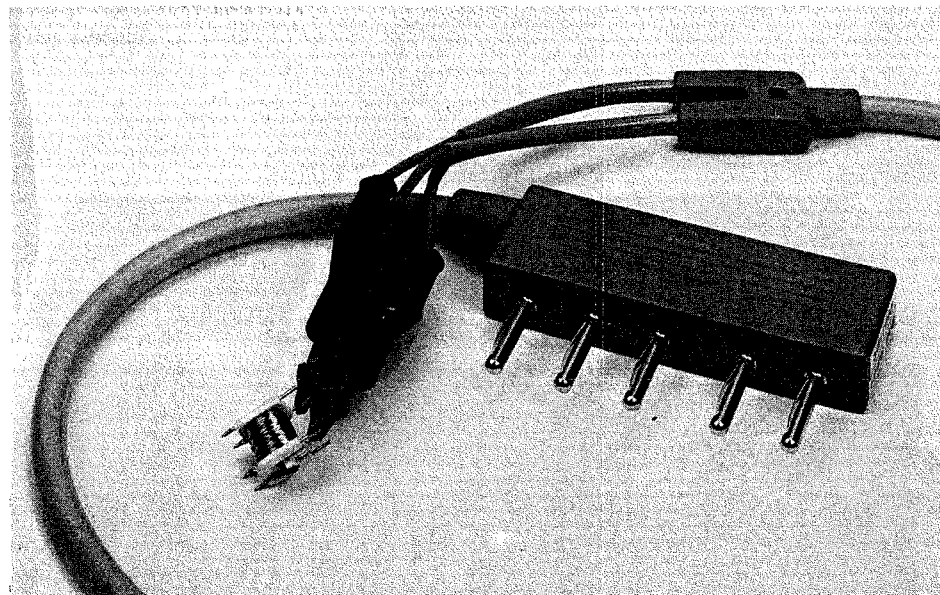

Fig. 33 4-wire test cable
4-Leiter Testkabel
Cable de test à 4 conducteur

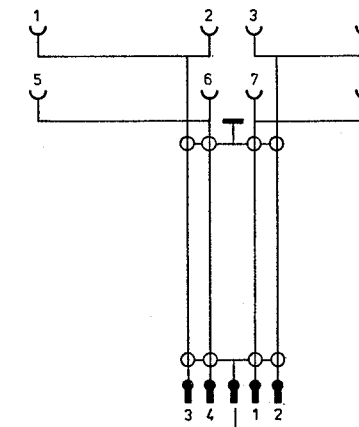
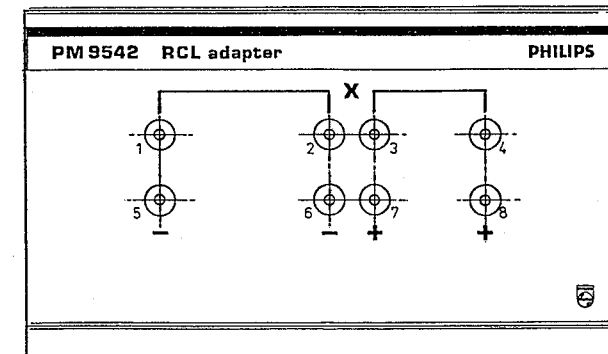

Fig. 34 RCL adapter
RCL Adapter
RCL adaptateur

Sales and service all over the world

Alger: Bureau de Liaison Philips,
24 bis, Rue Bougainville,
El Mouradia, Alger; tel.: 565672

Argentina: Philips Argentina S.A.,
Casilla de Correo 3479, (Central), 1430 Buenos Aires;
tel. 542-2411/51 and 41-4071/78

Australia: Philips Scientific & Industrial
Equipment Division, Centre Court,
25 - 27 Paul Street, P.O. Box 119,
North Ryde/NSW 2113; tel. (2)888-8222

Bangla Desh: Philips Bangla Desh Ltd.,
P.O. Box 62; Rama, Dacca; tel. 234280

Belgia/Belgique: Philips & MBLE associated S.A.,
Scientific and Industrial Equipment Division,
80 Rue des Deux Gares, 1070 Bruxelles;
tel. (2) 523.00.00

Bolivia: Industrias Bolivianas Philips S.A.,
Cajón Postal 2964, La Paz;
tel.: 351581

Brasil: Philips do Brasil Ltda,
Avenida 9 de Julho 5229, Caixa Postal 8681,
CEP 01407 - Sao Paulo (S.P.);
tel. 2821611

Service Centre:
Sistemas Profissionais
Rua Amador Bueno, 474,
Caixa Postal 3159 - S. Amaro,
CEP 04752 - Sto Amaro (S.P.);
tel. (11) 2476522

Canada: Philips Test and Measuring Instruments Inc.,
2375 Steeles Avenue West, Unit 126,
Downsview (Ontario) M3J-3A8;
tel. (416) 665-8470

Chile: Philips Chilena S.A.,
Division Profesional, Avda. Santa Maria 0760,
Casilla Postal 2687, Santiago de Chile; tel. 770038

Colombia: Industrias Philips de Columbia S.A.,
Calle 13 no. 51-39, Apartado Aereo 4282,
Bogota; tel. 2600600

Danmark: Philips Elektronik-Systemer A/S,
Afd. for Industri og Forskning, Strandlodsvej 4,
P.O. Box 1919, 2300 København S;
tel. (1) 572222

Deutschland (Bundesrepublik): Philips GmbH,
Unternehmensbereich Elektronik für
Wissenschaft und Industrie, Miramstrasse 87,
Postfach 310 320; 35 Kassel-Bettenhausen;
tel. (561) 5010

Ecuador: Philips Ecuador S.A.,
Casilla 4607, Quito; tel. 396100

Egypt: Resident Delegate Office of Philips Industries,
5 Sherif Street, Corner Elouï, P.O. Box 1687, Cairo;
tel. 754039/754257

Eire: Philips Electrical (Ireland) Ltd.,
Newstead, Clonskeagh, Dublin 14; tel. (1) 693355

España: Philips Ibérica S.A.E.,
Dpto Aparatos de Medida, Martínez Villergas 2,
Apartado 2065, Madrid 27;
tel. (1) 4042200
Service Centre:
Dpto Tco. de Instrumentación,
Calle de Albasanz 75, Madrid 17;
tel. (1) 2047100

Ethiopia: Philips Ethiopia (Priv. Ltd. Co.),
Ras Abebe Aregay Avenue,
P.O.B. 2565,
Addis Ababa; tel. 448300

Finland: See Suomi

France: S.A. Philips Industrielle et Commerciale,
Science et Industrie,
105 Rue de Paris, 93 002 Bobigny;
tel. (1) 8301111

Great Britain: Pye Unicam Ltd., York Street,
Cambridge CB1-2PX; tel. (223) 358866
Service Centre:
Beddington Lane, Croydon, Surrey CR9-4EN;
tel. (1) 6843670

Greece: See Hellas

Hellas: Philips S.A. Hellénique,
54 Avenue Syngrou, P.O. Box 153,
Athens 403; tel. (1) 9215311

Hong Kong: Philips Hong Kong Ltd.,
Hopewell Centre, 27-29th floor,
No. 17, Kennedy Road, P.O. Box 2108,
Wanchai, Hong Kong;
tel. (5) 283298
Service Centre:
Hopewell Centre, 16th floor;
tel. (5) 283575

India: Philips India, Peico Electronics & Electrical Ltd.,
S&I Equipment, Shivsagar Estate,
Block "A", Dr. Annie Besant Road,
P.O.B. 6598, Worli, Bombay 400 018 (WB);
tel. 391431

Indonesia: P.T. Philips Development Corporation,
Department for Science and Industry Wisma PeDe,
Jalan Let. Jen. Haryono M.T. Kav. 17,
P.O.B. 2287, Jakarta-Selatan; tel. (21) 820808

Iran: Philips Iran Ltd., P.O.B. 1297, Teheran;
tel. 372081/5

Iraq: Philips Iraq W.L.L., Munir Abbas Building,
4th floor, South Gate, P.O. box 5749, Baghdad;
tel. 8880409

Island: Heimilsteaki SF, Sættún 8, Reykjavik;
tel. 24000

Islas Canarias: Philips Ibérica S.A.E.,
Triana 132, Las Palmas, Casilla 39-41,
Santa Cruz de Tenerife

Italia: Philips S.p.A., Sezione S&I/T&M,
Viale Elvezia 2, 20052 Monza; tel. (39) 36351

Jamaica: Philips (Jamaica) Ltd.,
Savannah Av. & Washington Blvd.,
P.O. Box 61, Kingston - 6;
tel. 92 - 53041

Japan: See Nippon

Jordan: Philips Delegate Office,
P.O. Box 35268, Amman; tel. 43998

Kenya: Philips (Kenya) Ltd.,
01 Kalou Road, Industrial Area,
P.O.B. 30564, Nairobi; tel. 557999

Kuwait: Delegate Office of Philips Industries,
P.O. Box 3801, Safat, Kuwait; tel. 428678

Lebanon: Philips Middle East S.A.R.L.,
P.O. Box 11670, Beirut; tel. 285748/9

Malaysia: Philips Malaysia Snd Bhd.,
Professional Division,
Lot 2, Jalan 222, Section 14,
P.O. Box 2163, Petaling Jaya,
Selangor; tel. 774411/562144

México: Philips Mexicana S.A. de C.V.,
Div. Científico Industrial, Calle Durango 167,
Apartado Postal 24-328, Mexico 7 (D.F.);
tel. 544-91-99/525-15-40

Morocco: S.A.M.T.E.L., Casa Bandoeng,
B.P. 10896, Casablanca 05; tel. 303192/302992

Nederland: Philips Nederland,
Hoofdgroep PPS, Boschdijk 525, Gebouw VB,
5600 PB Eindhoven; tel. 793333
Service centre:
Technische Service Prof. Activiteiten,
Hurksestraat 42, Gebouw HBK,
5652 AL Eindhoven; tel. 723094/722295

Ned. Antillen: Philips Antillana N.V.,
Postbus 523, Willemstad, Curaçao;
tel. 414071/74

New Zealand: Philips Electrical Industries of N.Z. Ltd.,
Scientific and Industrial Equipment Division,
68-86 Jervis Quay, P.O. Box 2097,
Wellington C1; tel. 735735

Nigeria: Associated Electronic Products (Nigeria) Ltd.,
Ikorodu Road, P.O.B. 1921, Lagos; tel. 900160/61

Nippon: NF Trading Co. Ltd.,
Kirimoto Bldg. 11-2,
Tsunashima Higashi 1 - Chome, Kohoku-ku,
Yokohama

Norge: Norsk A.S. Philips,
Dept. Industry and Telecommunication
Postboks 1, Manglerud, Oslo 6; tel. (2) 680200

Osterreich: Oesterreichische Philips Industrie GmbH,
Abteilung Industrie Elektronik,
Parttargasse 34, A-1230 Wien;
tel. (222)-841611/15.

Pakistan: Philips Electrical Co. of Pakistan Ltd.,
El-Markz, M.A. Jinnah Road, P.O.B. 7101,
Karachi 3; tel. 70071

Paraguay: Philips del Paraguay S.A.,
Av. Artigas 1497,
Casilla de Correo 605, Asunción;
tel. 291924

Perú: Philips Peruana S.A.,
Av. Alfonso Ugarte 1268,
Apartado Aereo 1841, Lima 100; tel. 326070

Philippines: Philips Industrial Development Inc.,
2246 Pasong Tarno, P.O.B. M.C.C. 911,
Makati, Metro, Manila; tel. 868951/868959

Portugal: Philips Portuguesa S.A.R.L.,
Av. Eng.º Duarte Pacheco 6, Apartado 1331, Lisboa 1000;
tel. (19) 683121
Service Centre:
Serviços Técnicos Profissionais, Outurela,
2795 Linda-a-Velha; tel. (19) 683121

Saoudi Arabia: Delegate Office Philips Industries,
Sabreen Bldg., Airport Road, P.O. Box 9844,
Riyadh; tel. 4777808/4778463

Schweiz-Suisse-Svizzera: Philips A.G.,
Allmendstrasse 140, Postfach, CH-8027 Zürich;
tel. (1) 4882211/4882629

Singapore: Philips Singapore Private Ltd.,
Lorong 1, Tao Payoh, 1st floor,
P.O. Box 340, Toa Payoh Central Post Office,
Singapore 1231; tel. (2) 538811/537622

South Africa: South African Philips (Pty) Ltd.,
2 Herb Street, New Doornfontein, P.O.B. 7703,
Johannesburg 2000; tel. (11) 6140411

South-Korea: Philips Electronics (Korea) Ltd.,
G.P.O. Box 3680, Seoul; tel. 794 5011/5

Suomi: Oy Philips AB.,
Kaivokatu 8,
P.O. Box 10255,
SF-00101 Helsinki 10; tel. 17271
Service Centre:
P.O. Box 11, SF-02631 Espoo 63;
tel. (0) 523122

Sverige: Philips Försäljning AB,
Div. Industrielektronik, Lidingsvägen 50,
Fack, S-11584 Stockholm; tel. (8) 635000

Syria: Philips Moyen-Orient S.A.R.L., Rue Fardoss 79,
Immeuble Kassas and Sadate, B.P. 2442, Damas;
tel. 118605/221650

Taiwan: Philips Taiwan Ltd.,
San Min Building, 57-1 Chung Shan North Rd., Sec. 2,
P.O. Box 22978, Taipei;
tel. (2) 5631717

Tanzania: Philips (Tanzania) Ltd.,
P.O. Box. 20104, Dar es Salaam; tel. 29571

Thailand: Philips Electrical Co. of Thailand Ltd.,
283 Silom Road, P.O. Box 961, Bangkok 5;
tel. 233-6330/9

Tunisia: S.T.I.E.T., 32 bis, Rue Ben Ghedhahem,
Tunis; tel. 244268

Türkiye: Türk Philips Ticaret A.S.,
Posta Kutusu 504, Bevgölu,
Istanbul 1; tel. 435910

United Arab Emirates: Philips Middle East B.V.,
Dubai International Trade Centre, Level 11,
P.O. Box 2969, Dubai; tel. 475267

Uruguay: Industrias Philips del Uruguay S.A.,
Avda Uruguay 1287, Casilla de Correo 294,
Montevideo; tel. 915641

U.S.A.:
Philips Test and Measuring Instruments Inc.,
California, Garden Grove 92645
12882 Valley View Street, Suite 9;
tel.: (213) 594-8741/(714) 898-5000
California, Milpitas 95035
489 Valley Way;
tel. (408) 946-5722
Florida, Winter Park 32789
1850 Lee Road, Suite 229;
tel. (305) 628-1717
Georgia, Norcross 30071
7094 Peachtree Industrial Blvd., Suite 220;
tel. (404) 586-0238
Illinois, Itasca 60143
500 Park Blvd., Suite 1170;
tel. (312) 773-0616
Massachusetts, Woburn 01801
21 Olympia Avenue;
tel. (617) 935-3972
Minnesota, Minneapolis 55420
7801 Metro Parkway, Suite 109;
tel. (612) 854-2426
New Jersey, Mahwah 07430
85 McKee Drive;
tel. (201) 529-3800, Toll-free (800) 631-7172

Venezuela: Industrias Venezolanas Philips S.A.,
Av. Ppal de los Ruicos,
Apartado Aereo 1167, Caracas 107;
tel. (2) 393811/353533

Zaire: S.A.M.E./S.Z.A.R.L., B.P. 16636, Kinshasa;
tel. 31693

Zambia: Philips Electrical Zambia Ltd.,
Mwenbeshi Road, P.O.B. 31878, Lusaka;
tel. 218511

Zimbabwe: Philips Electrical (PVT) Ltd.,
62 Umtali Road, P.O. Box 994, Beverley/Harare;
tel. 47211

For information on change of address:
Philips Export B.V.,
Scientific and Industrial Equipment Division,
Test and Measuring Instruments, Building TQ III-4, P.O. Box 218,
5600 MD Eindhoven - The Netherlands

For countries not listed here:
Philips Export B.V., S&I Export,
Test and Measuring Instruments, Building TQIII-3, P.O. Box 218,
5600 MD Eindhoven - The Netherlands;
Tel. (40) 782285