

RCL meter

PM 6303

9452 063 03001

Service manual

9499 525 00911

84 03 01/1



PHILIPS

Please note

In correspondence concerning this instrument, please quote the type number and serial number as given on the type plate.

Bitte beachten

Bei Schriftwechsel über dieses Gerät wird gebeten, die Typennummer und die Gerätenummer anzugeben. Diese befinden sich auf dem Typenschild an der Rückseite des Gerätes.

Noter s. v. p.

Dans votre correspondance et dans vos réclamations se rapportant à cet appareil, veuillez toujours indiquer le numéro de type et le numéro de série qui sont marqués sur la plaquette de caractéristiques.

Important

As the instrument is an electrical apparatus, it may be operated only by trained personnel. Maintenance and repairs may also be carried out only by qualified personnel.

Wichtig

Da das Gerät ein elektrisches Betriebsmittel ist, darf die Bedienung nur durch eingewiesenes Personal erfolgen. Wartung und Reparatur dürfen nur von geschultem, fach- und sachkundigem Personal durchgeführt werden.

Important

Comme l'instrument est un équipement électrique, le service doit être assuré par du personnel qualifié. De même, l'entretien et les réparations sont à confier aux personnes suffisamment qualifiées.

© Philips GmbH – Hamburg – Germany – 1984

All rights are strictly reserved.

Reproduction or divulgation in any form whatsoever is not permitted without written authority from the copyright owner.

Issued by Philips GmbH -Unternehmensbereich Elektronik für Wissenschaft und Industrie- Werk für Meßtechnik

Printed in Germany

CONTENTS

1.	SAFETY INSTRUCTIONS	
1.1.	Safety precautions	1-1
1.2.	Caution and warning statements	1-1
1.3.	Symbols	1-1
1.4.	Impaired safety-protection	1-1
1.5.	General clauses	1-1
2.	OPERATING PRINCIPLE	
2.1.	Description of the block diagram	2-1
2.2.	Measuring principle	2-2
Fig. 1	One single measurement	2-3
Fig. 2	One measurement cycle	2-3
Fig. 3	Block diagram	2-4
Fig. 4	Front view	2-4
3.	CIRCUIT DESCRIPTION, FAULT FINDING, with figs. 5 -13	
3.1.	Crystal clock, frequency divider, phase selector	3-1
3.2.	Component connection, buffer, inverting amplifier	3-1
3.3.	Current to voltage converter	3-3
3.4.	Programmable amplifier	3-3
3.5.	Band-pass filter 2	3-3
3.6.	Level detector	3-3
3.7.	Phase sensitive rectifier	3-3
3.8.	Analog to digital converter, ADC	3-4
3.9.	Central processing unit, CPU	3-6
3.10.	Parameter selection	3-6
3.11.	Liquid-crystal display, LCD	3-7
3.12.	Power supply	3-10
3.13.	Self-test program, Error messages	3-10
3.14.	Diagnostic program	3-11
4.	ACCESS TO PARTS	
4.1.	Dismantling the cabinet	4-1
4.2.	Unit 2: display unit	4-1
4.3.	Pushbuttons	4-1
4.4.	Carrying handle	4-1
5.	PERFORMANCE CHECK	
5.1.	General information	5-1
5.2.	General functional test	5-1
6.	CHECKING AND ADJUSTING	
6.1.	General information	6-1
6.2.	Recommended test equipment	6-1
6.3.	Table of checks and adjustments	6-2

7.	SAFETY INSPECTION AND TESTS AFTER REPAIR AND MAINTENANCE IN THE PRIMARY CIRCUIT	
7.1.	General directives	7-1
7.2.	Safety components	7-1
7.3.	Checking the protective earth connection	7-1
7.4.	Checking the insulation resistance	7-1
8.	SPARE PARTS	
8.1.	General	8-1
8.2.	Static sensitive components	8-1
8.3.	Handling MOS devices	8-1
8.4.	Parts list	8-2
9.	FIGURES 15 - 18	
Fig. 15	Handle: spare parts	
Fig. 16	Mains cable: spare parts	
Fig. 17	Unit 1, Unit 2: component lay-outs	
Fig. 18	Unit 1, Unit 2: circuit diagrams	
10.	CODING SYSTEM OF FAILURE REPORTING FOR QUALITY	
11.	ADDRESSES FOR SALES AND SERVICE	

1. SAFETY INSTRUCTIONS

WARNING:

These servicing instructions are of use by qualified personnel only. To reduce the risk of electric shock, do not perform any servicing other than that specified in the Operating Instructions unless you are fully qualified to do so.

Read these pages carefully before installation and use of the instrument.

The following clauses contain information, cautions and warnings which must be followed to ensure safe operation and to retain the instrument in a safe condition.

Adjustment, maintenance and repair of the instrument shall be carried out only by qualified personnel.

1.1. SAFETY PRECAUTIONS

For the correct and safe use of this instrument it is essential that both operating and servicing personnel follow generally-accepted safety procedures in addition to the safety precautions specified in this manual. Specific warning and caution statements, where they apply, will be found throughout the manual. Where necessary, the warning and caution statements and/or symbols are marked on the apparatus.

1.2. CAUTION AND WARNING STATEMENTS

CAUTION:

Is used to indicate correct operating or maintenance procedures in order to prevent damage to or destruction of the equipment or other property.

WARNING:

Calls attention to a potential danger that requires correct procedures or practices in order to prevent personal injury.

1.3. SYMBOLS



Protective earth (black)
(grounding) terminal

1.4. IMPAIRED SAFETY-PROTECTION

Whenever it is likely that safety-protection has been impaired, the instrument must be made inoperative and be secured against any unintended operation. The matter should then be referred to qualified technicians.

Safety protection is likely to be impaired if, for example, the instrument fails to perform the intended measurements or shows visible damage.

1.5. GENERAL CLAUSES

1.5.1.

WARNING:

The opening of covers or removal of parts, except those to which access can be gained by hand, is likely to expose live parts and accessible terminals which can be dangerous to live.

1.5.2.

The instrument shall be disconnected from all voltage sources before it is opened.

1.5.3.

Bear in mind that capacitors inside the instrument can hold their charge even if the instrument has been separated from all voltage sources.

1.5.4.

WARNING:

Any interruption of the protective earth conductor inside or outside the instrument, or disconnection of the protective earth terminal, is likely to make the instrument dangerous. Intentional interruption is prohibited.

1.5.5.

Components which are important for the safety of the instrument may only be renewed by components obtained through your local Philips organisation (see also chapter 8).

1.5.6.

After repair and maintenance in the primary circuit, safety inspection and tests, as mentioned in chapter 8, have to be performed.

2. OPERATING PRINCIPLE

2.1. DESCRIPTION OF THE BLOCK DIAGRAM, Fig. 3

The 16 MHz crystal clock generates the basic frequency for all signals, so the count pulses for the analog to digital converter ADC.

The frequency divider generates the 8 MHz clock pulse for the microprocessor and the 1 kHz test frequency in 3 reference phases, namely 0° , 90° and 180° .

In the phase selector the CPU selects the appropriate reference phase 0° , 90° or 180° for the phase sensitive rectifier and the ADC.

The band-pass filter 1 converts the TTL signal into a 1 kHz sine wave signal.

The test voltage amplifier amplifies the 1 kHz sine wave signal to a 2 V_{eff} open circuit voltage at the component under test (CUT) connection. In the 'Cs biased' mode 2 V_{dc} are added to the 1 kHz signal.

The isolating buffer senses the voltage at the CUT.

The inverting amplifier feeds a compensating current via capacitor C (90° phase shift) into the current to voltage converter input for equalizing the stray capacitances. The amplitude of the compensating current is set by Co TRIM.

The current to voltage converter converts the current through the CUT into a proportional voltage. The conversion factor can be switched by a factor of 10.

For current or voltage measurement the input of the subsequent differential amplifier is switched over by the voltage/current (V/I) selector controlled by the CPU.

In the programmable amplifier gain factors x0.1, x1 or x10 are selected by the CPU depending on the impedance of the CUT. For the reference measurement the input is short-circuited.

The 1 kHz band-pass filter 2 suppresses hum interference and reduces the harmonic components of the 1 kHz measurement signal.

The level detector compares the output voltage of band filter 2 with a preset reference value. If this value is exceeded, the CPU switches the programmable amplifier to a lower gain factor.

The phase sensitive rectifier generates dc voltages which are proportional to that component of the measuring voltage being in-phase with the reference voltage.

The analog to digital converter ADC converts the output signal of the rectifier into a binary number which can be processed by the CPU.

The central processing unit CPU with the inherent microprocessor controls and monitors the measurement process, computes and stores the measurement values and transfers the result to the display.

The LCD control transforms the serial data transmitted by the CPU into parallel data and controls the liquid-crystal display which operates in duplex mode.

In the LED control the parameter key actuations are verified and processed. The selected parameter is indicated by a LED. Simultaneously the information is BCD-coded and sent to the CPU, whereby the most significant bit directly switches on the 2 V_{dc} voltage, when the parameter Cs (2 V Bias) is set.

The power supply generates the required stabilized dc voltages +15 V, -15 V and +5 V for the circuitries.

2.2. MEASURING PRINCIPLE, Figs. 1, 2, 3

The **measurement principle** is based on the so-called **current and voltage measurement technique**: the component voltage and after that the component current are measured. The measured values are converted to binary numbers. From these numbers the CPU computes the CUT parameter of interest. According to the front panel parameter selection, either the dominating component —resistance, capacitance or inductance— or one of the other selectable parameters is displayed.

Each measurement cycle lasts approx. 0.5 s. It comprises **5 single measurements**, the results of which are stored in the microprocessor data memory, a subsequent arithmetic evaluation and a final transfer of the result to the display. The 5 single measurements are as follows:

1. Reference measurement:

At the beginning of each measurement cycle a reference measurement is performed, with the input of the programmable amplifier short-circuited, caused by low signal at pins 27, 28 of the microprocessor 309. The programmable amplifier is set to gain x.1. After a delay time of 50 ms for each of the 5 single measurements, necessary for settling of the zero control and the band-pass filter 2, a measurement without 1 kHz signal is performed, comprehending all failures within the signal path from FET switch 328 to the A/D converter. The counter contents of the A/D conversion at the end of this measurement serves as reference for the subsequent 4 measurements.

2. 0° voltage measurement:

The voltage at the CUT is measured.

The switching phase of the phase sensitive rectifier is 0° .

For voltage sensing at the CUT the inputs of the differential amplifier are connected via the V/I selector, FET switch 324, to the measurement input. This is achieved by low signal of the microprocessor 309.30. The 0° switching phase is activated by low signal 309.33. The gain of the programmable amplifier is set to x.1. After 5 ms settling time for the 1 kHz signal amplitude the output of the level detector is sensed, \overline{INT} , 309.6. If no overrange is detected —correct for the 100 k Ω resistor in our example— the gain is set to x1; the level detector is sensed again. As now overrange is detected the gain is set back to x.1 and an A/D conversion is started, 309.31. For low-ohmic CUTs the gain is set to maximum gain x10 and, if no overrange is detected, the measurement is performed.

3. 90° voltage measurement:

The voltage at the CUT is measured.

The switching phase of the phase sensitive rectifier is 90° .

The gain of the programmable amplifier is not altered with respect to the 0° voltage measurement. An A/D conversion is performed.

4. 0° current measurement:

The inputs of the differential amplifier are switched over to the output of the current to voltage converter.

The current through the CUT is measured.

The switching phase of the phase sensitive rectifier is 0° .

The gain of the programmable amplifier is set to x.1 and, as for voltage measurement, increased to x1 with regard to the level detector. Next, if necessary, the conversion coefficient of the I/V converter is increased from x1 to x10 (high at 309.30) and —as valid for our example with a 100 k Ω resistor— the gain of the programmable amplifier is increased to x10 and set back to x1 after overrange detection. An A/D conversion is performed.

For low-ohmic components a slightly different sequence is performed: If for voltage measurement the gain was set to x1 or x10, the impedance is in any case very low, resulting in maximum current to flow. The current measurement is performed at gain x.1 without trial for gain changing.

5. 90° current measurement:

The current through the CUT is measured.

The switching phase of the phase sensitive rectifier is 90°.

The gain of the programmable amplifier is not altered. A final A/D conversion is performed.

At the end of the 5 single measurements the 5 corresponding binary numbers of the A/D conversions and the assigned gain factors are stored in the microprocessor data memory. From this the microprocessor first calculates the equivalent series resistance R_s , the equivalent series reactance X_s and the quality factor $Q = X_s/R_s$ of the CUT. In the RCL AUTO mode the microprocessor determines the dominant component, either R_s resp. R_p , C_p or L_s , calculates its value, dimension and equivalent-circuit symbol by arithmetic routines and transfers the result to the display. If one of the 8 other parameters is selected by the step keys this parameter is calculated and displayed. After that the microprocessor starts the next measurement cycle with the single measurement routines.

For **fault finding** the 5 single measurements can statically be controlled, performed by the **diagnostic program**, see chapter 3.14.

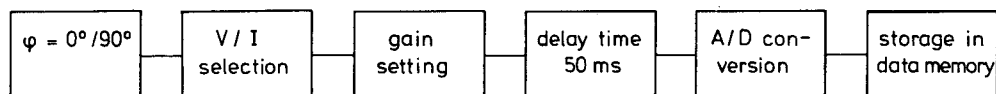

Fig. 1 One single measurement

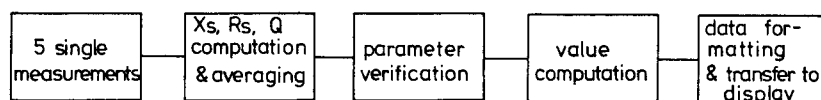

Fig. 2 One measurement cycle (ca. 0.5 s)

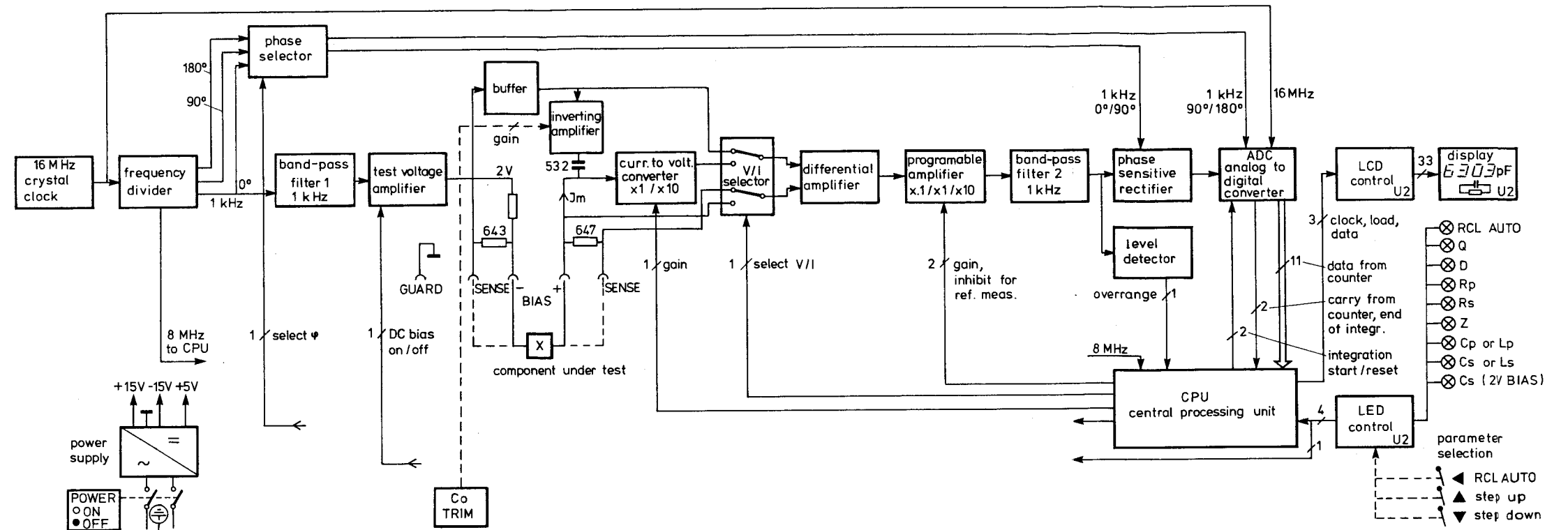

Fig. 3 Block diagram

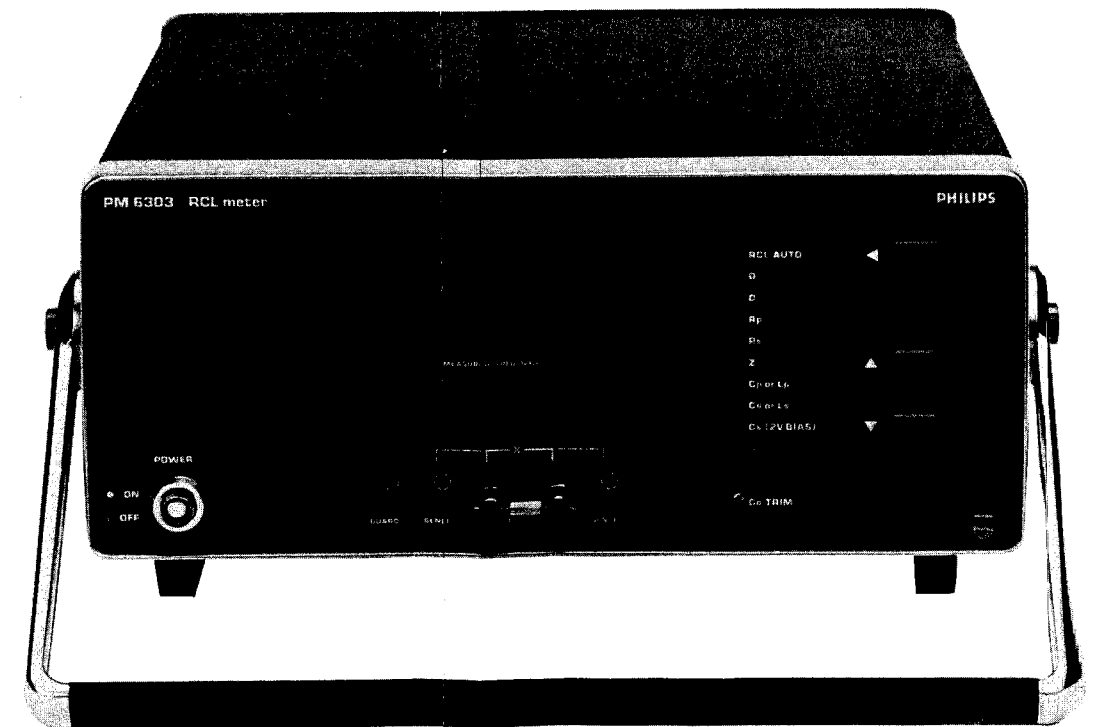

Fig. 4 Front view

3. CIRCUIT DESCRIPTION, FAULT FINDING

3.1. CRYSTAL CLOCK, FREQUENCY DIVIDER, PHASE SELECTOR

The accuracy of the 16 MHz clock frequency is moderate, $\pm 5 \cdot 10^{-5}$. So fixed load capacitances 506, 504 are inserted; they nevertheless may be altered in test, if necessary. The output of the oscillator is decoupled by inverter 307/2. 307/1 feeds the 16 MHz count pulses for the analog to digital converter ADC.

The first divider stage of the 4-bit binary counter 308 generates the 8 MHz clock pulse for the microprocessor. Its last stage feeds 1 MHz to the frequency divider chain.

IC 306 comprises two 4-bit BCD counters, the 5 : 1 division of which is used for dividing the frequency down to 40 kHz.

Further division by 10 results in a 4 kHz signal at output 304.9, the basic frequency for generation of the 1 kHz signals with different phase relations, see fig. 5. The trailing (high to low) edges trigger the J-K flipflops 303, 302. The 1 kHz signal, phase 0° , is fed to the band-pass filter 1. At the output 4 of the multiplexer 301 a 0° or 90° signal is available, selected ('select φ ') by the microprocessor. At output 7 a signal shifted by 90° with relation to pin 4 is available for synchronisation of the analog to digital converter ADC.

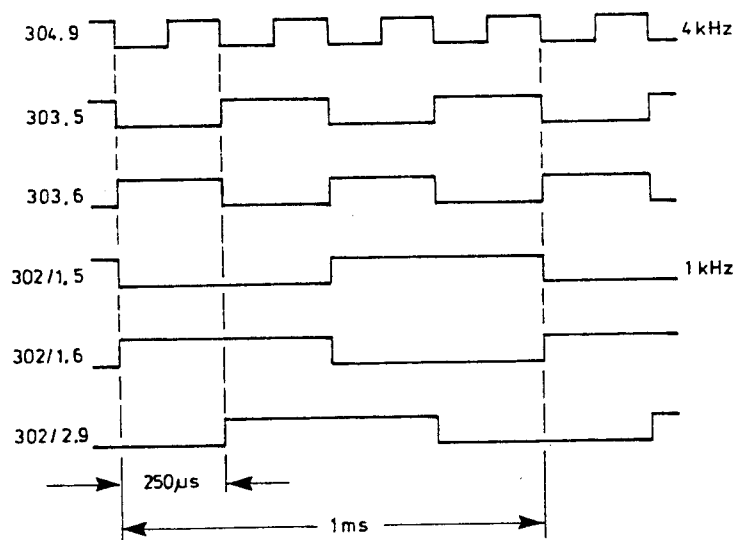

Fig. 5 Generation of the 1 kHz signals

3.2. COMPONENT CONNECTION, BUFFER, INVERTING AMPLIFIER

The recommendations in the operating manual, chapter 3.4, are valid for service operations too. For understanding the measurement of various types of components with respect to possible faults of the instrument and its accuracy, APPENDIX 1 of the operating manual —Algorithms in PM 6303, Phasor Diagrams of Various CUT Types— can be helpful. In general influences by series or parallel resistances implemented in the input/output circuitries of the CUT connections with respect to 2-wire or 4-wire system must be taken into account. Fig. 6 shows the network for 4-wire connection of a pure ohmic component.

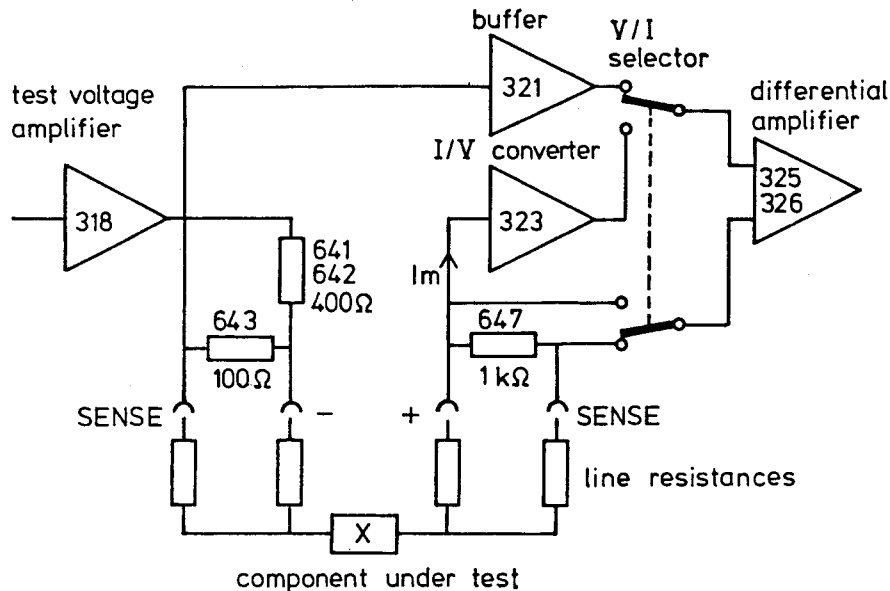

Fig. 6 Detailed circuitry for 4-wire CUT connection

Depending on measuring either high-ohmic or low-ohmic components this figure can be simplified. The contact resistance at the sockets may approx. be $50 \text{ m}\Omega$.

The 2 V measurement voltage is fed to the “-” socket, sensed at the appropriate SENSE socket. The current flows through the CUT to socket “+” and its voltage at the low end is sensed. For 2-wire measurement of high-ohmic components the appropriate sense and drive sockets are interconnected by resistors 643 and 647.

The Guard socket is internally connected to measurement earth. The impedances between the 4 other sockets and Guard are of minor importance: currents leaking off at the driving side are not measured. At the current sink the voltage is virtual zero; so no current is leaking off.

In a 2-wire system the impedance at the “sense-” socket with respect to Guard must be taken into account, but it is of no importance, if it is $> 100 \text{ k}\Omega$, so not acting as voltage divider with the 100Ω resistor R643.

The **buffer amplifier** 321 serves for impedance conversion from high-ohmic sensing the measurement voltage to further signal processing. The signal is ac coupled (C531) in order to suppress the dc voltage in Cs Bias mode.

The **inverting amplifier** 322 shifts the phase of the buffer output voltage by 180° . So the current through C532 is able to compensate a capacitive portion of the measurement current. The output amplitude of the amplifier is adjustable by potmeter 638, in order to compensate the zero capacitance (no component connected) of the CUT connections or of different adapters and cables.

3.3. CURRENT TO VOLTAGE CONVERTER

The I/V converter, IC 323, converts the CUT current into a proportional output voltage. Differential sensing the current at the feed-back resistor 651 or 652 allows measurement of low impedances down to 1 m Ω . FET switch 319/1 switches the conversion coefficient (gain), x1 or x10, by selecting feed-back resistor 651 or 652. The tolerance of these resistors must be 0.05 %, as it directly influences the measurement accuracy of the instrument.

By separate switching the current path and the voltage sensing at the resistors the on-resistances of the FET switches are eliminated. Resistor 653 and Z-diodes 406, 407 limit the amplitude at input 4 of the FET switch to ± 5 V. Voltages above ± 5.5 V will destroy the switch!

3.4. PROGRAMMABLE AMPLIFIER

In the inverting amplifier 327 feed-back resistors are switched. FET switch 328 selects the resistors 661, 662 or 663 for gain setting x0.1, x1 or x10 depending on the impedance of the CUT. As voltage and current measurements as well are performed by the programmable amplifier, the absolute gain accuracy is of no importance; only the accuracy of the gain factors x10 between the 3 gain settings are important; so the resistors mentioned have accuracies of 0.05 %.

Capacitors 539, 540, 541 are paralalled to the resistors in order to achieve equal bandwidths and so equal phase errors for the 3 gain settings.

2-pole switching of the feed-back resistors eliminates the on-resistances of the FET switch. Via the upper switch contacts the high-ohmic input of IC 329 senses the voltage at the feed-back resistors.

Selecting the different gains is done at inputs 9 and 10 of IC 328, binary coded, controlled by ports P10, P11 of the microprocessor. For the reference measurement within the measurement cycle, code 00, the input of 329 is set to ground. Codes 01 to 11 correspond to the gains x0.1 to x10.

3.5. The **BAND-PASS FILTER 2** suppresses hum interference coupled into the CUT and reduces the harmonic components of the 1 kHz signal. The gain at 1 kHz is 0.98. The damping is about 29 dB at 100 Hz and 17 dB at 3 kHz.

3.6. The **LEVEL DETECTOR** comprises the comparator 332 and the retriggerable monostable multivibrator (flip-flop) 333. If the positive peak value of the measurement signal exceeds the reference value of 2.8 V, preset by voltage divider 674, 676, the output of the comparator generates pulses with 1 kHz repetition frequency, which trigger the flip-flop. As the duration of the output pulse is determined by the timing components R678 and C546 to ca. 2 ms, the output 9 is set to low, as long as the comparator detects overrange (retrigger function of the flip-flop). The microprocessor 309 detects the overrange signal at the INT input —used as normal input port— and switches the programmable amplifier to a lower gain factor, ports P10, P11.

3.7. The **PHASE SENSITIVE RECTIFIER** resolves the CUT voltages into components along the two reference phases and converts them to dc voltages. It is essentially an on/off switch for the CUT voltage V_m .

Without input voltage V_m , i.e. during the reference measurement, 1 kHz pulses of about 4.4 V_{op} are available at the output of buffer 335.6. The pulse amplitude and rise and fall times must be stable for at least one measurement cycle, achieved by differential switch 364/365 and reference diode 414. The phase of the switching pulses in relation to the test voltage is selectable to 0° and 90° by 'select ϕ ', IC 301.1. The measurement voltage V_m at the input of the rectifier (330.6) is superimposed on the pulses mentioned above only during the half cycle:

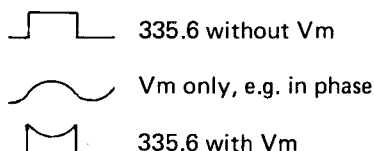

The maximum portion of V_m is ± 30 % with respect to the dc pulse amplitude, achieved by $V_m = \text{ca. } 2 V_{\text{eff}}$ being in-phase or anti-phase related to the switching signal.

3.8. ANALOG TO DIGITAL CONVERTER, ADC

The output from the phase sensitive rectifier is converted into digital data by a dual-slope analog to digital converter. The ADC comprises integrator 336, zero control 337, comparator 341, ADC control 338, 339 and a 19-bit counter. The latter is composed by the 11-bit counter 344, 345 and an 8-bit counter within the microprocessor 309.

Oscilloscope drawings in Fig. 7 show one complete measurement cycle. Fig. 8 enlightens one conversion period of the ADC within one of the single measurement cycles.

High signal of the microprocessor 309.31 prepares the conversion at t_1 . The time $t_2 - t_1$ may vary from 0 to 1 ms (1 pulse duration). The start pulse duration is 1.5 ms. The trailing edge of the 1 kHz signal 301.7 sets the output 338/1.5 high to start the integration at t_2 : the zero control is switched off and the output of the phase sensitive rectifier is connected via FET switch 334/1 to the input of the integrator. This is done during the zero period of the measurement pulses. For this the 1 kHz signal shifted by 90° with reference to the switching phase of the phase sensitive rectifier is taken.

The integrator reference current, defined by resistors 702, 703, is equal for integration (t_2 to t_4) and de-integration (discharge slope, t_4 to t_5). The difference between input current, defined by measurement voltage pulses and resistor 701, and the integrator reference current effects the output voltage of the integrator to go in negative direction during integration. At t_2 flip-flop 340 and counter 339 are activated. The flip-flop divides the 1 kHz frequency by 2 feeding the down counter 339 which was preset to 10. At t_3 , counter state 7, high signal 339.6 resets the 11-bit counter to zero. Low signal 339.7 resets flip-flop 303/2 of the comparator enabled again at t_4 . At t_4 the counter state is zero. At the trailing edge of the 1 kHz signal the output 339.13 generates a short low pulse resetting 338/2 and so terminating the integration and starting the de-integration. The integration period $T_1 = 20$ ms comprises 20 1 kHz pulses; so zero- and time-symmetrical 50 Hz noise and its odd harmonics have no influence on the measurement result.

When 338/2 is reset at t_4 , all 3 enable inputs at NAND gate 343 are high; so the 16 MHz count pulses can pass to the 11-bit counter. The carry of the 11-bit counter toggles the 8-bit counter within the microprocessor, input 39.

At t_5 the output voltage of the integrator crosses the zero level causing the comparator and the flip-flop 303/2.9 to turn over to low. This signal 'end of integration' disables gate 343 to stop the 16 MHz count pulses. The counter state at t_5 is proportional to the integrator output voltage at t_4 and consequently to the measurement value. For reference measurement the integrator output is ca. 5 V at t_4 resulting in $T_2 =$ ca. 15 ms, corresponding to 240.000 count pulses. The maximum counter state is ca. $475.000 \hat{=} T_2 = 29.7$ ms, the minimum is ca. $5000 \hat{=} T_2 = 0.3$ ms. So for the measurement range ca. ± 235.000 count pulses are available.

As the tilt of the de-integration is independent of the measurement value, the delay time between zero crossing and comparator turn-over and so the increase of the counter state for every single measurement cycle is equal. So the difference of the counter states is not effected.

The output 303/2.9 of the comparator is sensed by the CPU at input 1. Low signal at t_5 , 'end of integration', causes the CPU to store the 19-bit counter contents into the data memory. The CPU sends a reset pulse at t_6 preparing the circuitry for the next single measurement cycle: the zero control is activated decreasing the integrator output voltage to zero. In the rest position the zero control has to compensate the integrator reference current.

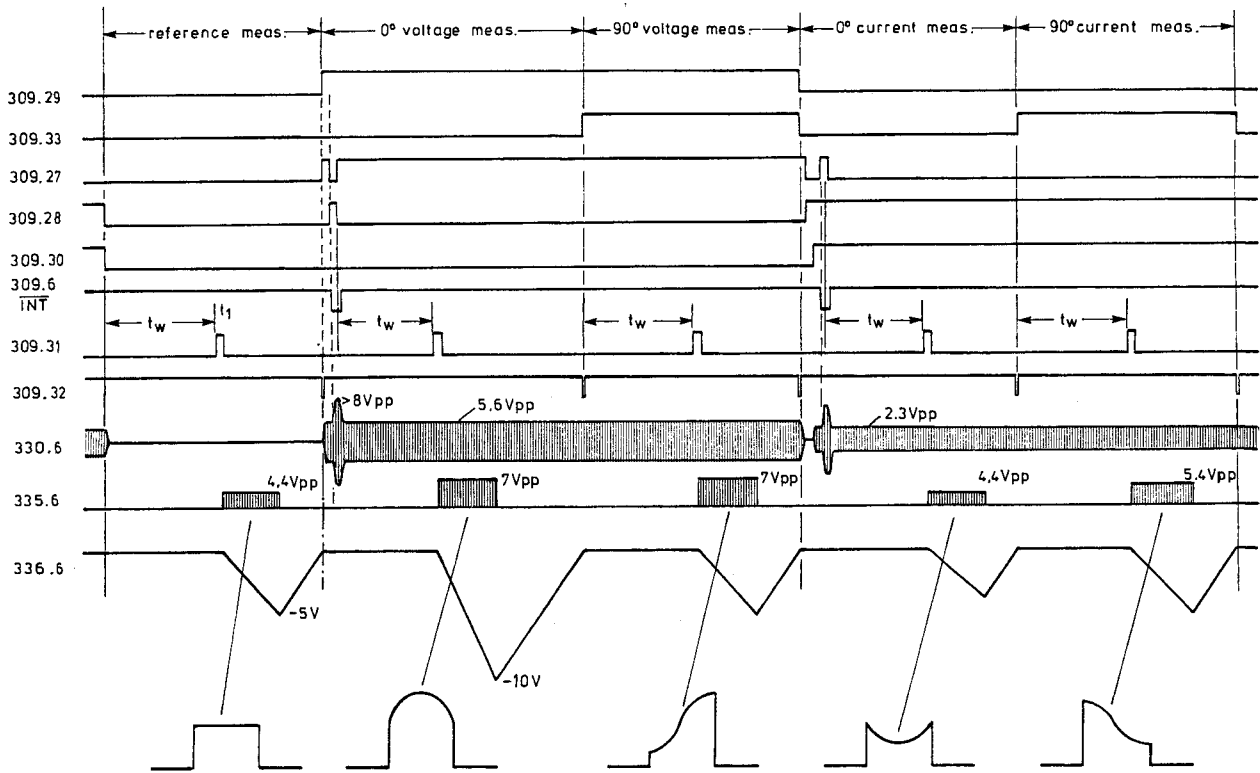

Fig. 7 One complete measurement cycle (CUT = 100 kΩ)

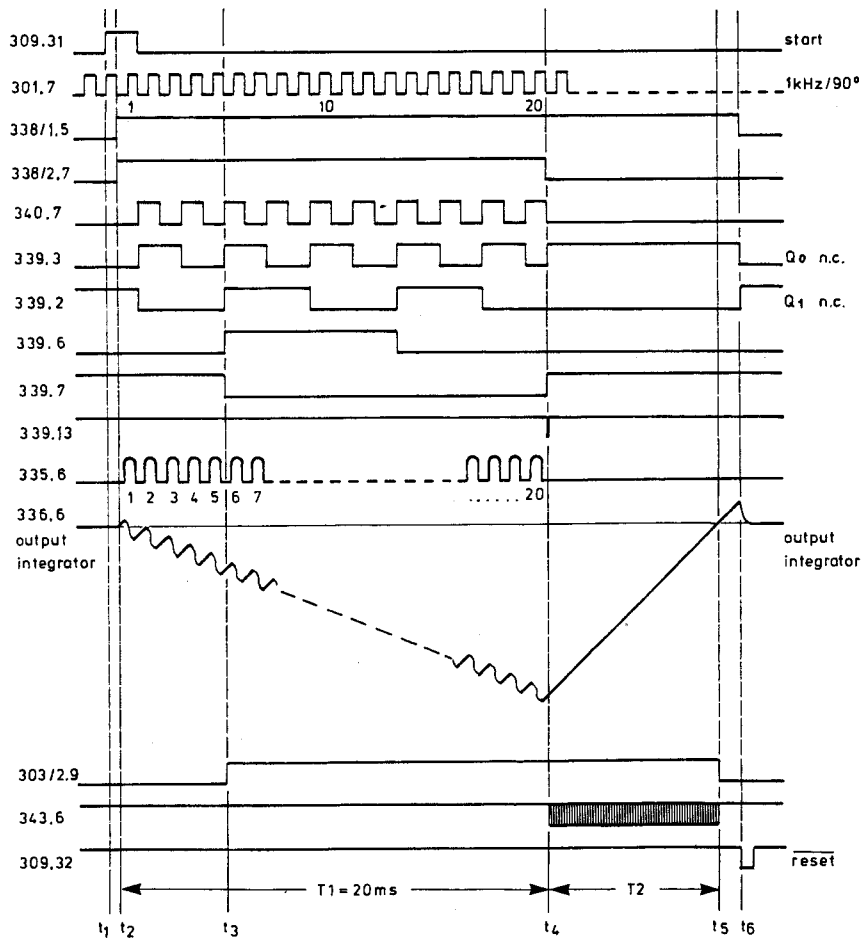

Fig. 8 One conversion period of the ADC

3.9. CENTRAL PROCESSING UNIT, CPU

In the circuit diagram you will notice a well-known standard circuitry with 8-bit microprocessor 8039, address latch 74363 and 32 K program memory 2732. The 16 MHz clock frequency is divided by 2, 308.9, and anti-phase fed to the clock inputs of the microprocessor via inverters 307. Ports P10 - 16 deliver the different control signals. Ports P24, 25 in combination with the read signal \overline{RD} select the tri-state input buffer for data transfer from the 11-bit counter and from the parameter selection on unit 2. Port P26, DLEN, data latch enable, controls the display driver on unit 2; port P27, CLB, clock burst, delivers the clock pulses for the serial data transmitted via P17. For the sequence of data transfer from the microprocessor to the display driver and display see chapter 3.11.

3.10. PARAMETER SELECTION

The selected parameter is defined by the state of the 4-bit binary up/down counter 355 on unit 2. The state is sensed by the microprocessor on unit 1 and evaluated for correct parameter display. The most significant bit – at high level only at counter state 8, parameter Cs (2 V BIAS) – directly actuates the FET switch 319/2 which switches on the 2 Vdc bias voltage. The appropriate LED is switched on by the 1-of-10 active HIGH decoder 352 and the open-collector drivers 353, 354.

The 3 keys "RCL AUTO", "▲" (up) and "▼" (down) are setting the state of the bi-directional counter 355:

The RCL AUTO key sends high to the reset input thus resetting the counter. After POWER ON the RC combination 753/593 resets the counter so defining the default mode RCL AUTO of the instrument.

Shortly pushing either the ▲ or ▼ key effects changing the counter state by 1. Continuous stepping at a rate of 2 steps per second in the marked direction is effected, when the keys are kept pushed. The retriggerable monostable multivibrators (monoflops) 358/1 and /2 serve for debouncing the key contacts. The keys connect the output of the astable multivibrator comprising IC 357/1, 357/2, R760 and C798 to the inputs of the monoflops. The output pulse duration of the monoflop (ca. 60 ms) is longer than the period of the multivibrator signal. Because of the retrigger function of the monoflops the outputs 7 resp. 9 remain low as long as one key is kept pushed. Max. one pulse duration (ca. 60 ms) after release of the key the output of the monoflop returns to its initial state.

IC 358/1 switches over, when one of the two keys ▲, ▼ is pushed; it generates count pulses via the intermediate counter 356 for the up/down counter 355. The second monoflop 358/2 only switches over, when the ▲ key is pushed; it defines the count direction of 355.

As long as the 'pushed' output 7 of 358/1 shows high level (initial state), the intermediate counter is reset to zero. When one of the keys is pushed, the counter 356 starts counting, clocked by the astable multivibrator. On leaving the counter state zero the carry output 7 (TC) turns high. This leading edge triggers the counter 355. As long as the 'pushed' output is kept low, at every zero passage of the counter, i.e. after every 16 clock periods of the multivibrator, the leading edge of the carry output TC changes the state of the counter 355 by 1. If the signal 'pushed' is reset to high, the counter 356 is reset.

The up/down counter 355, a 4 bit binary counter as 356, selects 9 parameters. Limiting the counter length is done by connecting the binary outputs 1 (pin 6) and 8 (pin 2) –high at transitions 8 to 9 and 0 to 15– via gate 357 to the load input 1. A short load pulse sets the counter to 0 or 8, depending on the 'down' signal at input 3. So the counter is continuously counting the 9 states in both directions. The RC combinations R752/C595 and R751/C594 suppress unwanted load pulses during transition from 7 to 8 resp. 8 to 7, caused by counter 355.

3.11. Liquid-crystal display, LCD

A three-line bus structure (CLB (Clock Burst), DLEN, DATA) enables serial data transfer from the microprocessor to the display unit. In this case the data are serially transmitted to the memory of the LCD duplex driver 351/U2. The data are transmitted to the driver memory 351, unit 2, which performs a word format check for 2 correct data words. After that they are transferred to the display.

The 53 display segments operate in duplex mode, i.e. two groups of segments are assigned to one backplane each. A segment is activated by HIGH of the relevant data bit. The relation of the data bits to the outputs and pins of the driver and the display are shown in figs. 9, 11.

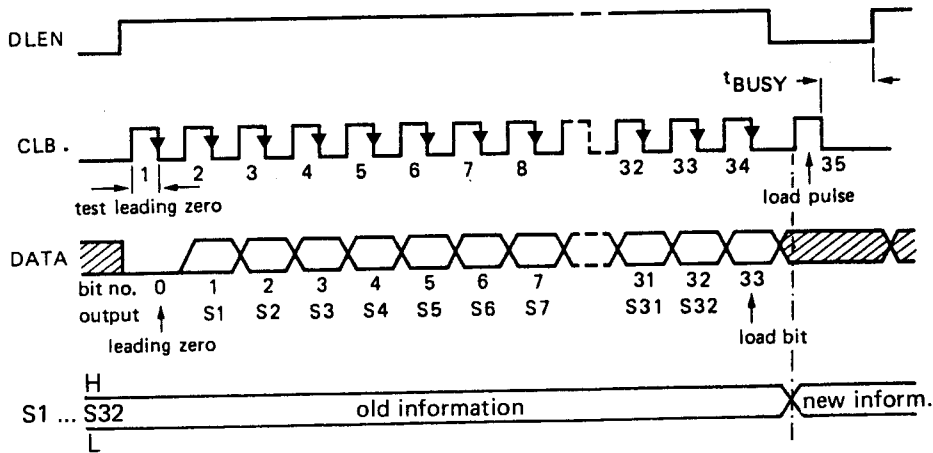

Fig. 9 Data format microprocessor (unit 1)/display driver (351, unit 2)

The clock oscillator with the RC combination R761/C599 and frequency divider generate the duplex signals BP1/BP2, $f_{LCD} \approx 80$ Hz. The single segments are connected between the outputs S1 ... S32 and backplane BP1 or BP2 resp. For a segment output S_x fig. 10 shows the possible control states. Because of the slow data transfer a storage oscilloscope is recommended for checking the display.

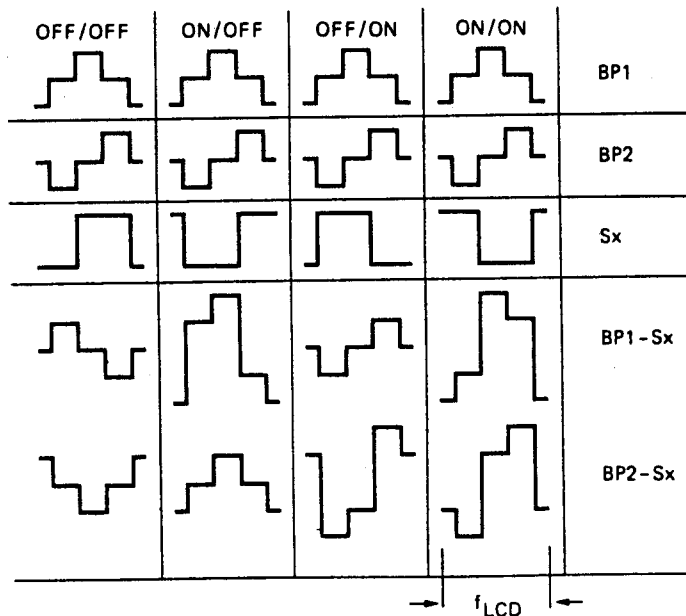
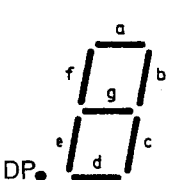







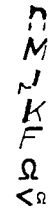







Fig. 10 Timing diagram display

Indication		LCD driver IC 351		Display					
		Outputs	Pin	Pin	BP1	Symbol	BP2	Symbol	
 <p>DP.</p> <p>Segment designation</p>	LSD	Digit 1	S32	5	50	—		b1	
			31	6	30	d1	c1		
			30	7	53	f1	a1		
			29	8	27	e1	g1		
	Digit 2	28	9	56	DP1	b2			
		27	10	24	d2	c2			
		26	11	59	f2	a2			
		25	12	21	e2	g2			
	Digit 3	S24	13	62	DP2	b3			
		23	14	18	d3	c3			
		22	15	65	f3	a3			
		21	16	15	e3	g3			
	MSD	Digit 4	20	17	67	DP3	b4		
			19	18	13	d4	c4		
			18	19	70	f4	a4		
			17	20	10	e4	g4		
Equivalent circuit		S16	21	78(2)	BAR7		—		
	15	22	3	BAR6		—			
	14	23	4	BAR5		—			
	13	24	76(5)	BAR1+2		—			
	12	25	74(6)	BAR3		—			
	11	26	73(7)	BAR8		—			
	10	27	72(8)	BAR4		—			
	9	28	9	DP4*	—	—			
Dimension		S8	29	33	Sym F		sym. G		
	7	30	48	Sym E		sym. A			
	6	31	35	Sym H		sym. J			
	5	32	47	Sym L		sym. B			
	4	33	37	Sym N		sym. R			
	3	34	38	Sym P		sym. D			
	2	35	45	Sym M		sym. C			
	1	36	—	—	—	—			
	BP2	37	40/41	—	—	—			
	BP1	38	1/80	—	—	—			

*used only during initial test





Fig. 11 Details of the display circuitry

Checking the data flow

By means of the signature analysis (CRC: Cyclical Redundancy Code) applying the PHILIPS PM 2544 logic multimeter or HP 5005A/5004A signature multimeter the serial data flow from microprocessor to display unit, but for backplane 1 only. The timing diagram of the transfer process is shown in fig. 12.

The following settings are required:

- PM 6303: select parameter Q
- PM 6303: connect metal film resistor 1 kΩ ... 2 kΩ to the test fixture
- PM 6303: correct display must show  0.000
- set logic (signature) multimeter to SIGNATURE NORMAL, trigger level: L ≅ 0.8 V H ≅ 2.0 V
- connect logic multimeter to μP 8039/unit 1

logic multimeter		PM 6303/U1	
setting, trigger	POD connector to	IC 309/U1	Pin
CLOCK  START  STOP 	Timing POD	clock burst	38 (P27)
	- CLOCK - START - STOP - GROUND 	DLEN	37 (P26)
		DLEN	37 (P26)
		Vss	20
	Data probe	DATA	34 (P17)

Logic Multimeter displays: 5 C 93

Data assigned to the 2 nd backplane of the display cannot be checked by this procedure.

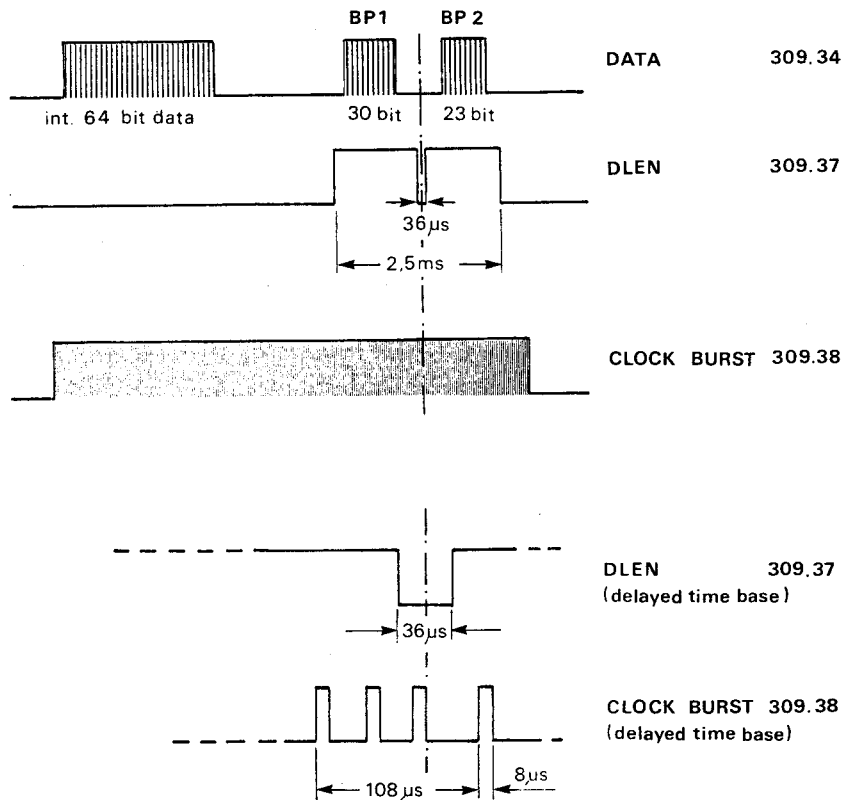

Fig. 12 Data transfer microprocessor /display unit

3.12. Power supply

Five voltages are generated by the power supply section:

+15 V and -15 V are stabilized by the four-terminal voltage regulators 346/347 and adjusted by pot-meters 723/727. Z-diodes 403/404 provide +5 V and -5 V for the zero-symmetrical operation of the FET analog switches 319, 324 and 328. The fixed +5 V supply voltage for the digital circuitries is outputted by the three-terminal voltage regulator 348.

The measuring earth for the analog and the digital circuitries have separate paths on the p.c.b. They are interconnected at the electrolytic capacitors 570, 573 and 579.

3.13. SELF-TEST PROGRAM, ERROR MESSAGES

For simple fault finding several test programs are realized in this instrument.

Moreover faults may be detected by other or conventional methods.

Generally the voltages of the power supply should be checked at first (see table checks and adjustments).

While the **self-test routine** is part of the normal program, the **diagnostic program** must be especially activated by closing solder link D (see Fig. 17, Unit 1).

The self-test routine is performed immediately after POWER ON. It confirms correct operation of the basic functions. For check of the display all segments of the decimal and dimension indications, decimal points and the equivalent-circuit symbols are shown for 3 seconds.

If a malfunction is detected an error code E0 ... E3 is shown in the display field for the numerical value. In this case equivalent-circuit symbols are not shown.

error code	malfunction	check position
E0	RAM test	μ P 8039 HL (IC 309)
E1	measuring ranges	programmable amplifier, level detector
E2	overflow counter of ADC	ADC control, e.g. IC338/IC339
E3	reference measurement	analog signal path, IC328 to IC336

3.14. DIAGNOSTIC PROGRAM

The diagnostic program is activated by closing the solder bridge D (see Fig. 17, Unit 1).

After switching on the instrument all segments of the display are shown for about 3 seconds followed by program 1, which is a display test in the default mode RCL AUTO. For selection of program 2-9 use one of the step buttons.

3.14.1. Survey of diagnostic program

Details of the program are explained in chapter 3.14.2.

test program	parameter setting	function	execution
1	RCL AUTO	display-test	display: 6303 equivalent-circuit symbols and dimensions are controlled automatically step-by-step
2	Q	preselection measuring range	indication of the measuring ranges: A, b1 ... b6 the last indicated measuring range is selected when program 2 is left.
3...7			the counter contents (16 MSB, hexadecimal) is repetitively displayed Note: $b_5 = b$, $b_6 = 6$ 1. measuring range A: complete measuring cycle and display of the selected value 2. measuring range b1 ... b6: repetitive single measurement of the selected voltage or current and display of counter contents
3	D	reference, measurement	display shows 6F00 ... 8b00
4	Rp	voltage measurement, phase 0°	displayed value depends on the CUT
5	Rs	voltage measurement, phase 90°	
6	Z	current measurement, phase 0°	
7	Cp or Lp	current measurement, phase 90°	
8	Cs or Ls	preselection measuring ranges	display indication: A, b1 ... b6 (identical to test program 2)
9	Cs (2V BIAS)	switch-over function	display shows intermittent: F0, F1 F0: switch over to program 1-8 F1: switch over to parameter measuring modes except Cs (2V BIAS), values are displayed decimal Note: the last indicated measuring range A, b1 - b6 selected during program 2 or 8 continuous in the other testprograms and parameter measuring modes.

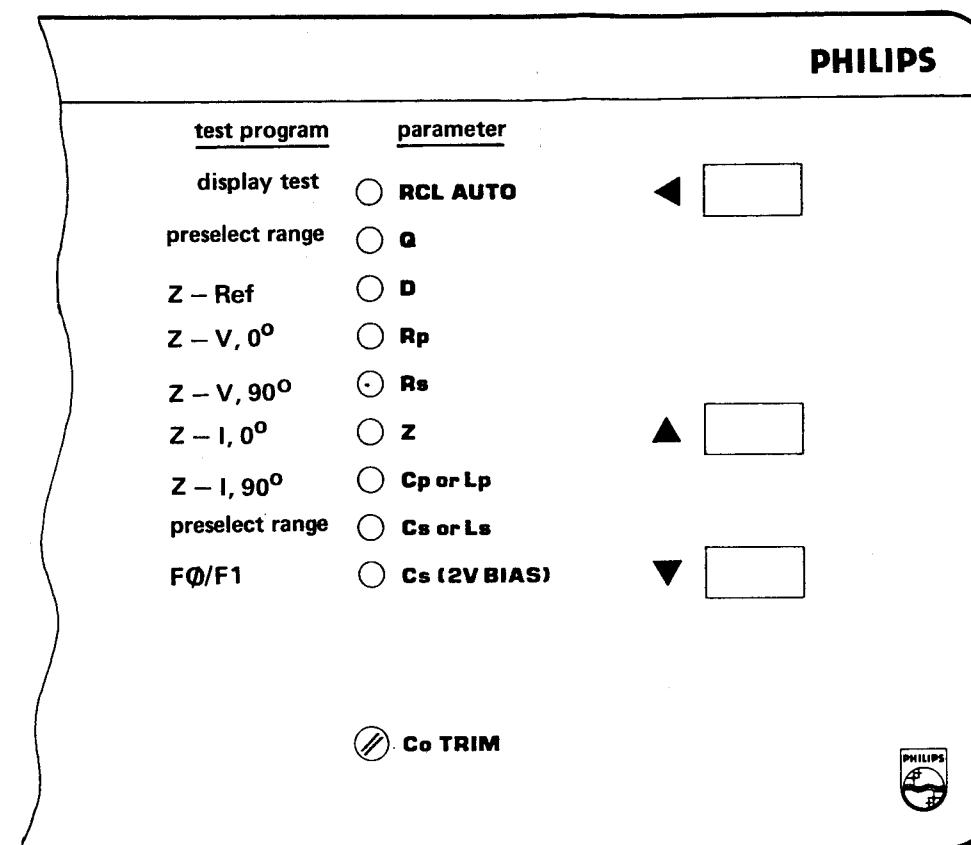
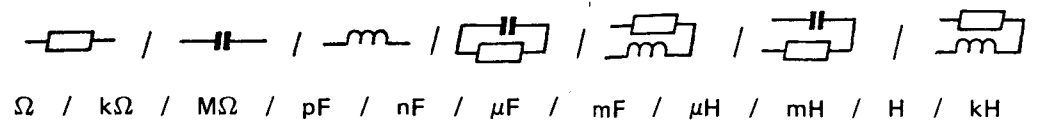

Fig. 13 Relation test program - parameter indication

3.14.2. The single test programs

3.14.2.1 Program 1: display test; parameter selection: RCL AUTO.

The display field for the numerical value shows permanently 6303. Additionally 7 equivalent-circuit symbols and 11 dimensions are displayed one after another:



Test program 1 stops when one of the step buttons is pressed.

3.14.2.2 Program 2, (8): Preselection of measuring ranges, parameter selection Q

The measuring ranges of the programmable amplifier are selected step-by-step and displayed hexadecimal. When switching over to another test program the last indicated measuring range is fixed during all test programs except program 8 which is identical to program 2.

Display indication:

A : Automatic setting of measuring ranges as used in normal operation mode. The amplification of the programmable amplifier is set dependent on the impedance of the CUT.

During test programs 3-7 complete measuring cycles are performed. One cycle comprises 5 single measurements: reference, 0° voltage, 90° voltage, 0° current and 90° current.

The displayed measuring value is dependent on the selected test program 3-7.

b1–b6: Setting the current- and voltage amplification of the prog. amplifier, setting the digital levels at port 1 of μP 8039 (see table chapter 3.14.2.7).

During test program 3-7 only the appropriate single measurement is realized in a cyclic way.

3.14.2.3 Program 3: Reference measurement, parameter selection D

The reference measurement only is performed in a cyclic way.

The display represents the 16 MSB of the counter state in hexadecimal notation.

The indicated value must be 6F00 ... 8B00.

Please well distinguish: $b = B$ $\bar{6} = 6$

3.14.2.4 Program 4 to 7

When test program 4 to 7 and a fixed measuring range b1 ... b6 is selected single repetitive measurements are realized. The programmable amplifier and μP port 1 are statically controlled. So the signal paths can be checked by means of an oscilloscope.

To prevent the amplifiers to be overdriven in the selected measuring range the connected CUT impedance must be within the Z-ranges as shown in chapter 3.14.2.7. The display represents the 16 MSB of the counter contents.

- program 4 parameter $R_p \hat{=} 0^\circ$ phase, voltage measurement
- program 5 parameter $R_s \hat{=} 90^\circ$ phase, voltage measurement
- program 6 parameter $Z \hat{=} 0^\circ$ phase, current measurement
- program 7 parameter C_p or $L_p \hat{=} 90^\circ$ phase, current measurement

3.14.2.5 Program 8: parameter Cs or Ls; (see program 2)

3.14.2.6 Program 9: Switch-over function; parameter Cs (2V BIAS)

The display alternately shows F0, F1.

Program 9 has no real function in the test program range; it serves for switch-over function:

When F0 is shown on the display it is possible to return to test program 1-8 by means of one of the step buttons or RCL AUTO. The measuring range still depends on the last setting during test program 2 or 8.

When F1 is shown switch over to the normal parameter measuring mode is possible. The measured value is displayed decimal. Preselection of the measuring range still depends on the last setting.

3.14.2.7 Measuring ranges, logic table for port 1 of the microprocessor

meas-range (hex. indication)	parameter	function	prog. amplifier	I/V converter	Z range	IC 309/U1				φ P16
						P10	P11	V/I P12	P13	
any	D	inhibit	—	—	—	L	L	L	X	L
b1	Rp	V, 0°	x10	—	$< 4 \Omega$ ↓	H	H	H	L	L
	Rs	V, 90°	x10	—		H	H	H	L	H
	Z	I, 0°	x.1	x1		H	L	L	L	L
	Cp/Lp	I, 90°	x.1	x1		H	L	L	L	H
b2	Rp	V, 0°	x1	—	$4 \Omega \dots 40 \Omega$ ↓	L	H	H	L	L
	Rs	V, 90°	x1	—		L	H	H	L	H
	Z	I, 0°	x.1	x1		H	L	L	L	L
	Cp/Lp	I, 90°	x.1	x1		H	L	L	L	H
b3	Rp	V, 0°	x.1	—	$40 \Omega \dots 4 \text{ k}\Omega$ ↓	H	L	H	L	L
	Rs	V, 90°	x.1	—		H	L	H	L	H
	Z	I, 0°	x.1	x1		H	L	L	L	L
	Cp/Lp	I, 90°	x.1	x1		H	L	L	L	H
b4	Rp	V, 0°	x.1	—	$4 \text{ k}\Omega \dots 40 \text{ k}\Omega$ ↓	H	L	H	L	L
	Rs	V, 90°	x.1	—		H	L	H	L	H
	Z	I, 0°	x1	x1		L	H	L	L	L
	Cp/Lp	I, 90°	x1	x1		L	H	L	L	H
b5	Rp	V, 0°	x.1	—	$40 \text{ k}\Omega \dots 400 \text{ k}\Omega$ ↓	H	L	H	L	L
	Rs	V, 90°	x.1	—		H	L	H	L	H
	Z	I, 0°	x1	x10		L	H	L	H	L
	Cp/Lp	I, 90°	x1	x10		L	H	L	H	H
b6	Rp	V, 0°	x.1	—	$> 400 \text{ k}\Omega$ ↓	H	L	H	L	L
	Rs	V, 90°	x.1	—		H	L	H	L	H
	Z	I, 0°	x10	x10		H	H	L	H	L
	Cp/Lp	I, 90°	x10	x10		H	H	L	H	H

3.14.3. SIMPLE check of measuring accuracy by means of the test program

By using fixed measuring ranges it is possible to check the accuracy of amplifier settings in a simple way. The impedance of the CUT should be selected according to the adjacent measuring ranges, e.g. for the measuring ranges b1 and b2 take a resistor of 4Ω (see table above). The tolerance of the CUT may be unspecified. The measured value can be read decimal in the parameter measuring mode.

For this procedure the solder bridge "D" must be closed.

Example:

- Connect the CUT, e.g. 4Ω , to the measuring input
- Select the measuring range b1 by test program 8
- Select test program 9 and use switch-over function to the parameter measuring mode.
- Press button RCL AUTO when F1 is shown on the display.
- Note the displayed value of the CUT.
- Press step button ▲ to select Cs (2V BIAS); use switch-over function during F0 to return to test program 8.
- Select measuring range b2.
- Return to the parameter measuring mode RCL AUTO.
- Compare the two results b1, b2.

The measured resistance values may deviate $< 1 \%$. Otherwise the settings/amplifications are faulty.

Tolerances of the quality factor Q, e.g. in the first measuring range $Q > 500$, in the second range $Q < 500$, indicates an additional phase error, when the gain factors are switched over.

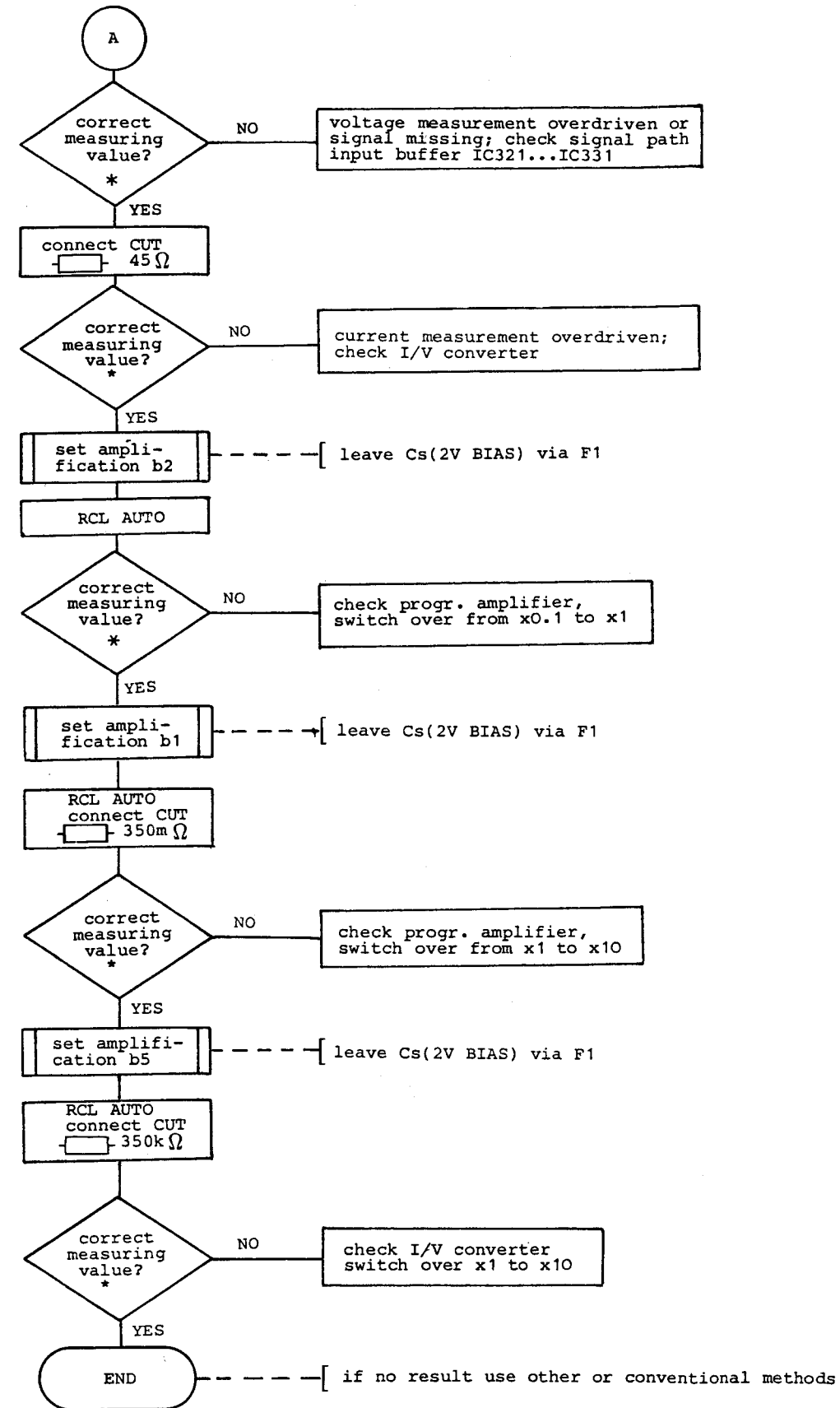
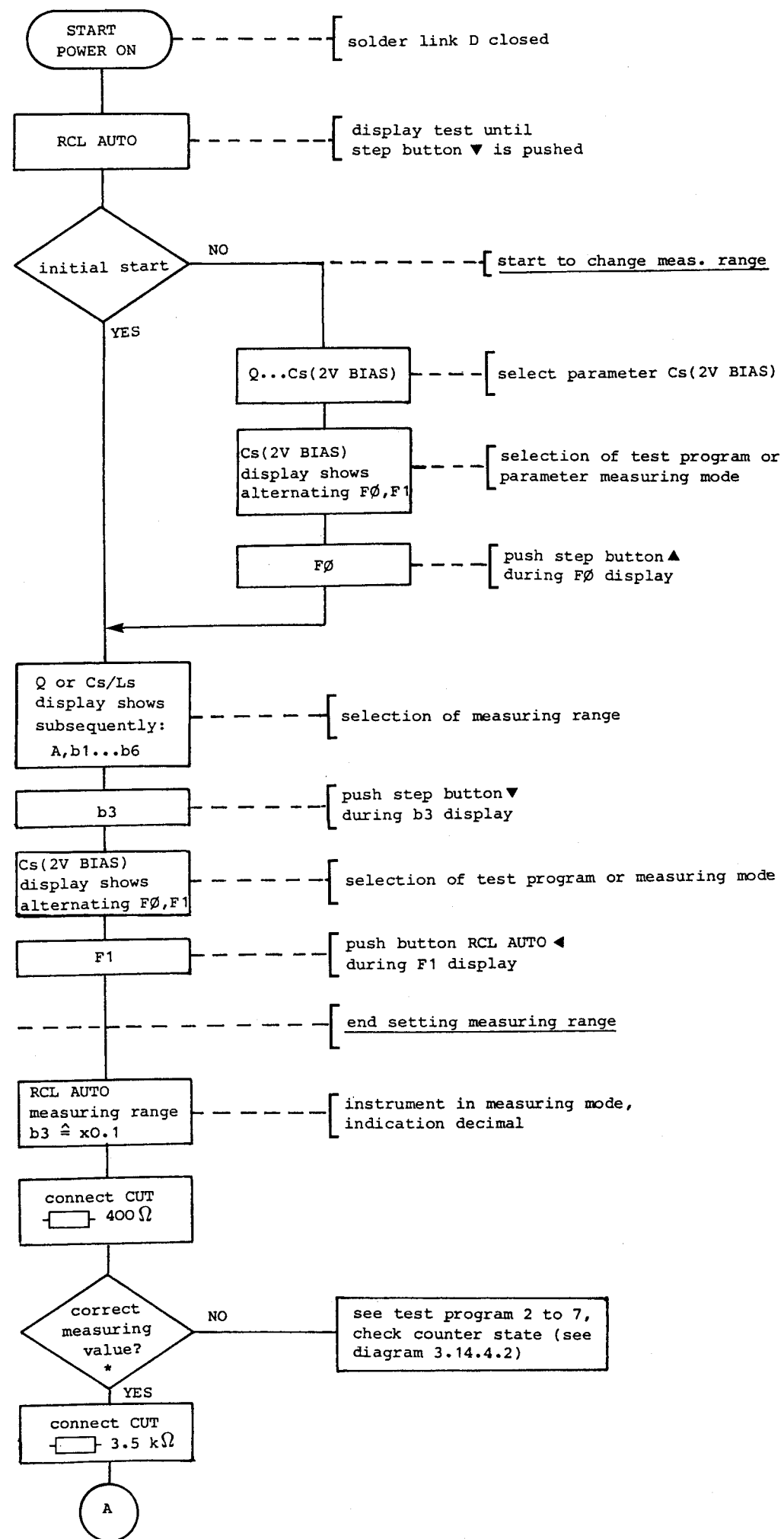

* tolerance of the value according to applied CUT; advised ±0.1 %

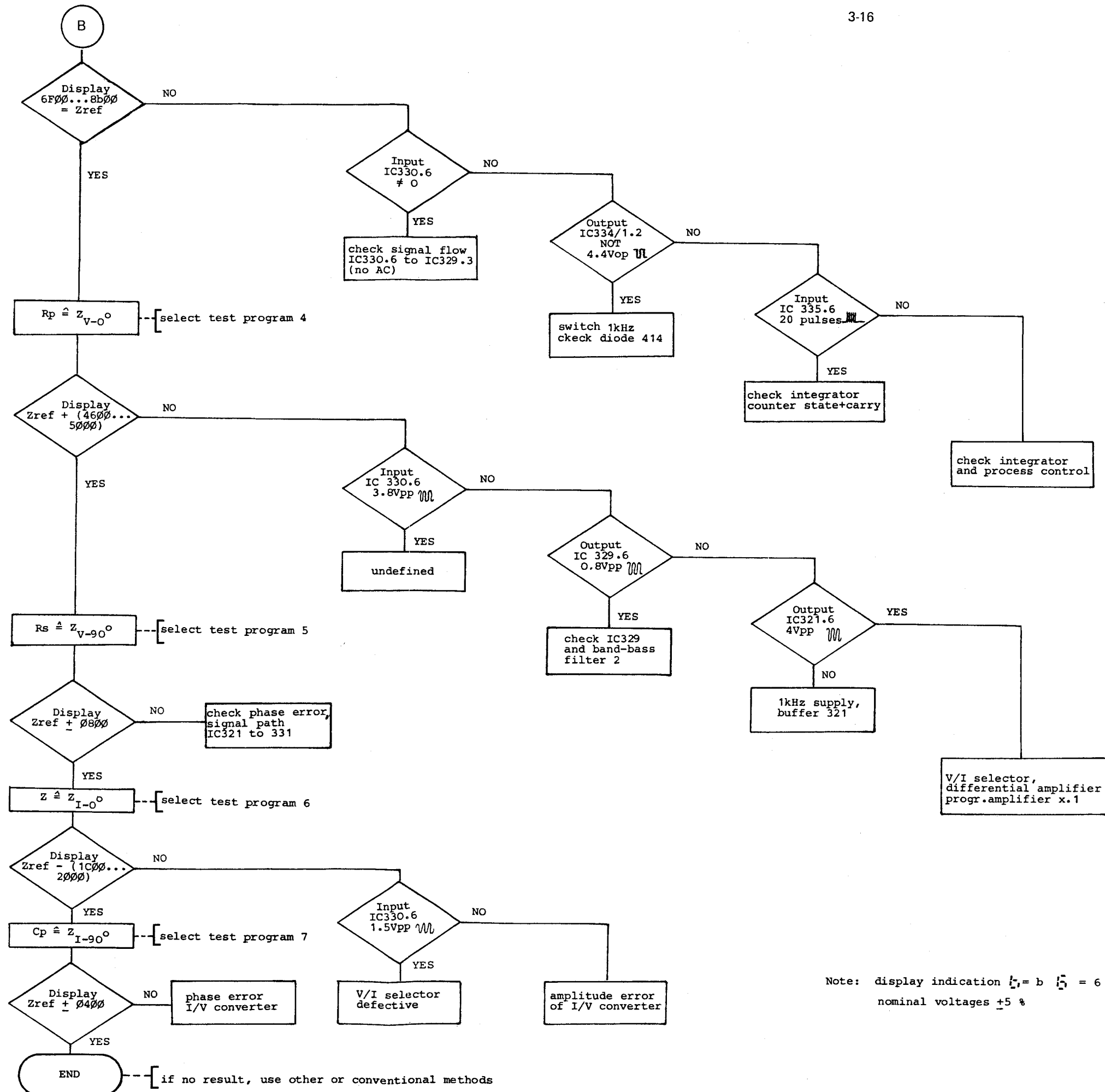
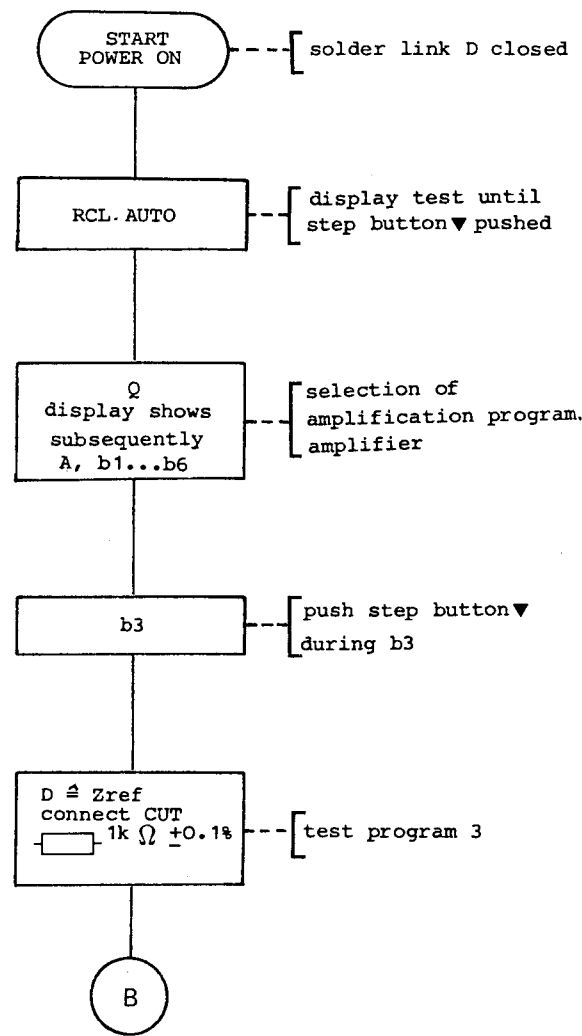

Note: display indication $b_1 = b$ $b_2 = 6$ nominal voltages ±5 %

4. ACCESS TO PARTS

4.1. DISMANTLING THE CABINET

- Unplug the mains connector
- Fold up the handle to the top. For this push the buttons of the handle
- Loosen the central screw at the rear
- Remove the lead-through of the mains cable from the cabinet
- Dismantle the cabinet

4.2. UNIT 2, DISPLAY UNIT

- Remove the cabinet, see 4.1.
- Remove the 5 screws of the PCB/U2 and disconnect cable plug BU3.
- All parts of unit 2 are now within easy reach and easy interchangeable.

4.3. PUSHBUTTONS

For changing knobs for pushbuttons it is necessary to open the cabinet and remove unit 2, see 4.2.

4.4. CARRYING HANDLE

- Prise off the centre knobs from each pivot, using a screwdriver in one of the small slots at the sides of the knobs.
- Remove the cross-head screws that are now accessible.
- Bend both arms of the handle slightly outwards and take it off the cabinet.
- Grip and arms of the carrying handle must be ordered separately (see mechanical parts list). A complete carrying handle can easily be constructed by pressing the arms into the grip.

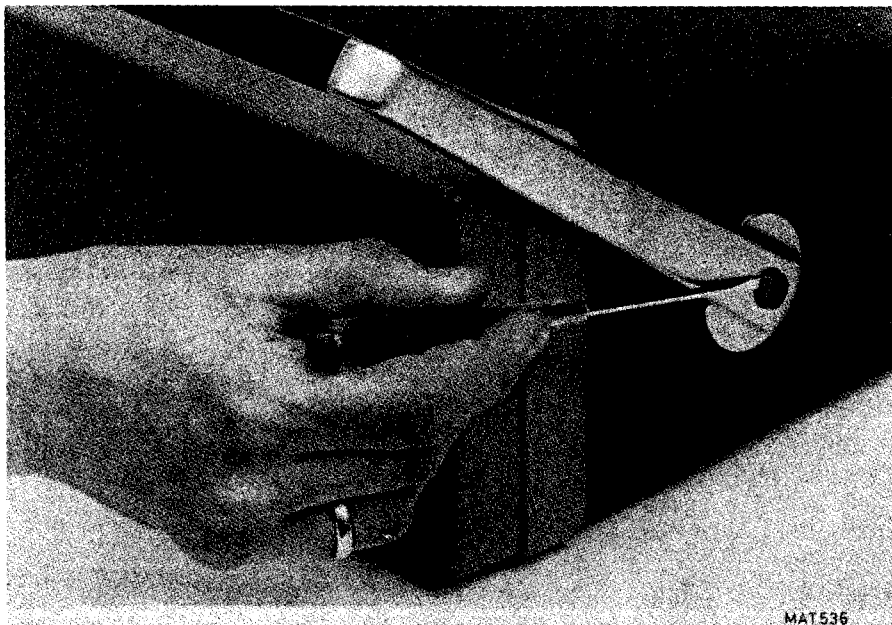

Fig. 14 Removing the carrying handle

5. PERFORMANCE CHECK

5.1. GENERAL INFORMATION

WARNING:

Before switching on, ensure that the instrument has been installed in accordance with the instructions outlined in Section 2: of the Operating Manual Installation instructions.

This procedure is intended to:

- check the instrument's specification
- be used for incoming inspection to determine the acceptability of newly-purchased instruments and/or recently-recalibrated instruments.
- check the necessity of recalibration after the recommended recalibration interval of 1 year.

ATTENTION:

The procedure does not check every detail of the instrument's calibration; rather, it is concerned primarily with those parts of the instrument which are essential to measurement accuracy and correct operation. Removing the instrument covers is not necessary to perform this procedure. All checks are made from the front panel.

If this test is started within a short period after switching on, bear in mind that steps may be out of specification, due to insufficient warming-up time. To avoid this situation, allow the specified warming-up time of 5 min.

5.2. GENERAL FUNCTIONAL TEST

- Set the instrument to POWER ON
- Check that the display shows for about 3 seconds all segments (decimal and dimension indications, decimal points and equivalent-circuit symbols).
- Check that the LED RCL AUTO is lighting (RCL AUTO is the default mode of the instrument).
- Disconnect any component or test cable/adapter from the input sockets of the RCL meter
- Check that display shows the following display reading:

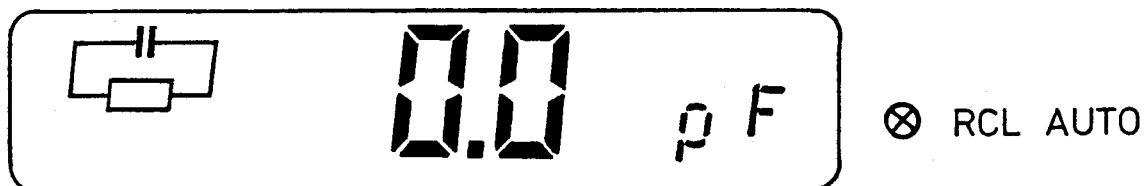

If necessary, perform compensation of the zero-capacitance by Co TRIM according to chapter 3.4.3 of the operating manual.

- Connect a precision resistor 0.1 % (e.g. 1 – 10 k Ω) or a resistor of which the exact value is known to the measuring input
- Check the correct measuring result.

6. CHECKING AND ADJUSTING

6.1. GENERAL INFORMATION

The following information provides the complete checking and adjusting procedure for the instrument. As various control functions are interdependent, a certain order of adjustment is often necessary. The procedure is, therefore, presented in a sequence which is best suited to this order, cross-reference being made to any circuit which may affect a particular adjustment. Before any check or adjustment, the instrument must attain its normal operating temperature.

- Warming-up time under average conditions is 5 minutes.
- Ambient temperature $(23 \pm 1)^\circ\text{C}$
- Mains voltage, nominal values $\pm 10\%$
- Where possible, instrument performance should be checked before an adjustment is made.
- All limits and tolerances given in this chapter are calibration guides, and should not be interpreted as instrument specifications unless they are also published in chapter 1.2. of the Operating Manual.
- Tolerances given are for the instrument under test and do not include test equipment error.
- If not explicitly stated otherwise, the voltage potentials refer to the relevant contact measured against measuring earth (\perp).

6.2. RECOMMENDED TEST EQUIPMENT

- The following abbreviations are used for settings and for the test equipments:

X \cong selected parameter mode

↓ \cong keep setting concerned

Vac, \cong Digital multimeter for a.c. and d.c. measurement, e.g. PM 2517, PM 2521

Vdc

OSC \cong Oscilloscope e.g. PM 3211

C/T \cong Counter/Timer e.g. PM 6670/02

CUT \cong Component under test:

Precision resistor, e.g. Philips type MPR 24/MPR34; precision capacitor.

If you have a Precision Decade Resistor available (accuracy $\pm 0.05\%$) the single resistors might not be necessary.

To avoid measuring error the GUARD must be connected.

Supplier of precision resistors can be asked from Supply Center Hamburg.

In addition some resistors are needed when performing the fault finding flow diagrams, chapter 3.4.

8. SPARE PARTS

8.1. GENERAL Standard Parts

Electrical and mechanical parts replacement can be obtained through your local Philips organisation or representative. However, many of the standard electronic components can be obtained from other local suppliers. Before purchasing or ordering replacement parts, check the parts list for value, tolerance, rating and description.

NOTE:

Physical size and shape of a component may affect instrument performance, particularly at high frequencies. Always use direct-replacement components, unless it is known that a substitute will not degrade instrument performance.

Special Parts

In addition to the standard electronic components, some special components are used:

- Components, manufactured or selected by Philips to meet specific performance requirements.
- Components which are important for the safety of the instrument, marked with 'S' in the parts list.

ATTENTION:

Both type of components may only be replaced by components obtained through your local Philips organisation.

8.2. STATIC SENSITIVE COMPONENTS

This instrument contains electrical components that are susceptible to damage from static discharge. Servicing static-sensitive assemblies or components should be performed only at a static-free work station by qualified service personnel.

8.3. HANDLING MOS DEVICES

Though all our MOS integrated circuits incorporate protection against electrostatic discharges, they can nevertheless be damaged by accidental over-voltages. In storing and handling them, the following precautions are recommended.

CAUTION:

Testing or handling and mounting call for special attention to personal safety. Personnel handling MOS devices should normally be connected to ground via a resistor.

8.4. PARTS LIST

8.4.1. MECHANICAL PARTS, miscellaneous, parts not on units

Item	Fig.	Quantity	Order number	Description	
1		2	5322 447 90395	cover	
2		4	5322 462 10222	foot (bottom side)	
3		2	5322 532 51481	bearing bush	
4		2	5322 530 84075	spring	
5		2	5322 528 34101	ratchet	
6		2	5322 532 51481	ring for handle	
7		2	5322 498 54048	arm for handle	
8		1	5322 498 54051	carrying handle	
9		2	5322 414 30043	knob	
10		1	5322 321 10333	mains cable	* S
11		1	5322 401 14275	cable clamp	* S
12		1	5322 325 64068	lead through	* S
13		1	5322 325 60119	pull relief	* S
14		4	5322 462 44176	foot (rear side)	
15		1	5322 502 14164	coin-slot screw (rear)	
16		1	4822 530 70124	locking washer (rear)	
851		1	5322 146 30478	mains transformer	* S
853		1	5322 276 14128	mains switch	* S
17		1	5322 447 94363	protection cap P.851	* S
852		1	4822 253 30007	fuse 125 mA	* S
-		1	4822 253 30013	fuse 250 mA	* S
18		2	4822 492 60063	fuse holder/U1	* S
19		3	5322 414 70031	knob pushbutton	
856-858		3	5322 276 11191	pushbutton switch/U2	
20		5	5322 267 30532	connector frontpl.	
21		1	5322 381 10683	window	
22		1	5322 255 44229	IC-socket, 24 pole	
23		2	5322 255 44235	IC-socket, 40 pole	
24		2	5322 255 40263	heat sink/U1	
25		3	5322 462 34125	printholder, plastic	
26		1	5322 267 64031	socket BU3/U2	
27		4	5322 255 40356	socket display 20P.	
28		1	5322 265 24026	2 term. test-fixture	
-		1	5322 390 24013	silicon paste 142G	

6303/1959

8.4.2. ELECTRICAL PARTS

Some parts are listed in chapter 8.4.1.

All metal film resistors not listed are of type MR25±1% 0.4W
(ordering code see end of this list).UNIT 1

<u>ITEM</u>	<u>DESCRIPTION</u>		<u>ORDERING CODE</u>		
<u>TRANSISTORS/U1</u>					
360,361	TRANSISTOR	BF494	4822	130	44195
362-365	TRANSISTOR	BC558B	4822	130	44197
366	TRANSISTOR	BC548B	4822	130	40937
367,368	TRANSISTOR	BC558B	4822	130	44197
<u>INTEGRATED CIRCUITS/U1</u>					
301	INTEGR. CIRCUIT	N74LS157N	5322	209	85489
302,303	INTEGR. CIRCUIT	N74S112N	5322	209	85741
304	INTEGR. CIRCUIT	N74LS290N	5322	209	86015
306	INTEGR. CIRCUIT	SN74LS390N	5322	209	86362
307	INTEGR. CIRCUIT	SN7405N-S1	5322	209	84434
308	INTEGR. CIRCUIT	N74LS293N	5322	209	86016
309	INTEGR. CIRCUIT	P8039HL	5322	209	10324
310	INTEGR. CIRCUIT	N74LS00N	5322	209	84823
311,312	INTEGR. CIRCUIT	N74LS244N	5322	209	86017
313	INTEGR. CIRCUIT	N74LS363N	5322	209	81776
314	INTEGR. CIRCUIT	HN462732G, LOADED	5322	209	50234
316	INTEGR. CIRCUIT	NE5538N	4822	209	80921
318	INTEGR. CIRCUIT	LF356N	5322	209	86451
319,324	INTEGR. CIRCUIT	HEF4053BP	5322	209	14121
321-323	INTEGR. CIRCUIT	LF356N	5322	209	86451
325	INTEGR. CIRCUIT	MC1458N	4822	209	81349
326,327	INTEGR. CIRCUIT	LF356N	5322	209	86451
328	INTEGR. CIRCUIT	HEF4052BD	4822	209	10263
329-332	INTEGR. CIRCUIT	LF356N	5322	209	86451
333	INTEGR. CIRCUIT	4528BP	5322	209	10277
334	INTEGR. CIRCUIT	HEF4066BP	5322	209	14104
335,336	INTEGR. CIRCUIT	LF356N	5322	209	86451
337	INTEGR. CIRCUIT	MC1456V	5322	209	84688
338,340	INTEGR. CIRCUIT	N74S112N	5322	209	85741
339	INTEGR. CIRCUIT	N74LS190N	5322	209	85491
341	INTEGR. CIRCUIT	LF357N	5322	209	80861
343	INTEGR. CIRCUIT	SN74LS20N	5322	209	85569
344	INTEGR. CIRCUIT	N74LS393N	4822	209	80447
345	INTEGR. CIRCUIT	N74LS293N	5322	209	86016
346	INTEGR. CIRCUIT	78GU1C	5322	209	85565
347	INTEGR. CIRCUIT	79GU1C	5322	209	86349
348	INTEGR. CIRCUIT	LM340T-5.0	4822	130	41223

ITEM	DESCRIPTION	ORDERING CODE
<u>DIODES/U1</u>		
401,402	DIODE, REFERENCE BZX79-B5V6	4822 130 34173
403,404	DIODE, REFERENCE BZX79-B5V1	4822 130 34233
405	DIODE BAW62	4822 130 30613
406-409	DIODE, REFERENCE BZX79-C4V3	4822 130 31346
410,411	DIODE, REFERENCE BZX79-B4V7	4822 130 34174
412,413	DIODE BAW62	4822 130 30613
414	DIODE, REFERENCE BZX93	5322 130 34397
415,422	DIODE, REFERENCE BZX79-B4V7	4822 130 34174
416	DIODE, REFERENCE BZX79-C4V3	4822 130 31346
417,424	DIODE, REFERENCE BZX79-B11	4822 130 34488
418,419	DIODE FDH300	5322 130 32047
421	DIODE BAW62	4822 130 30613
426,427	BRIDGE RECT. SKB2/08L5A	5322 130 32031
423	DIODE AA144	5322 130 32161
<u>CAPACITORS/U1</u>		
501	CAPACITOR, CERAM 22NF 80% 63V	5322 122 31795
503	CAPACITOR, CERAM 100NF 10% 50V	5322 122 32002
504	CAPACITOR, CERAM 12PF 2% 100V	5322 122 32054
506	CAPACITOR, CERAM 39PF 2% 100V	5322 122 31996
507	CAPACITOR, CERAM 220PF 2% 100V	5322 122 32056
508	CAPACITOR, CERAM 100PF 2% 100V	5322 122 32055
509	CAPACITOR, CERAM 100PF 2% 100V	4822 122 31316
511	CAP, ELECTROLYT. 68UF 40% 6,3V	4822 124 20941
512,513	CAPACITOR, CERAM 100NF 10% 50V	5322 122 32002
514	CAP, ELECTROLYT. 22UF 40% 10V	4822 124 20943
516	CAPACITOR, CERAM 22NF 80% 63V	5322 122 31795
517,518	CAP, ELECTROLYT. 22UF 50% 25V	4822 124 20698
519,521	CAPACITOR, FOIL 10NF 1% 63V	5322 121 54154
522,523	CAPACITOR, CERAM 22NF 80% 63V	5322 122 31795
524	CAPACITOR, FOIL 10NF 1% 63V	5322 121 54154
525	CAPACITOR, CERAM 4,7PF0,25PF 100V	5322 122 32053
526	CAPACITOR, FOIL 10NF 1% 63V	5322 121 54154
527-529	CAPACITOR, CERAM 22NF 80% 63V	5322 122 31795
530	CAPACITOR, CERAM 2,2NF 10% 100V	4822 122 30114
531	CAPACITOR, CERAM 100NF 10% 50V	5322 122 30108
532	CAPACITOR, CERAM 10PF 2% 100V	4822 122 31054
533-538	CAPACITOR, CERAM 22NF 80% 63V	5322 122 31795
539	CAPACITOR, FOIL 2.7NF 1% 160V	5322 121 54065
540	CAPACITOR, FOIL 270PF 1% 630V	5322 121 54047
541	CAPACITOR, CERAM 15PF 2% 100V	4822 122 31058
542,543	CAPACITOR, CERAM 22NF 80% 63V	5322 122 31795
544,545	CAPACITOR, FOIL 10NF 1% 63V	5322 121 54154
546	CAP, ELEC. TANTAL 220NF 20% 35V	5322 124 14074
547	CAPACITOR, FOIL 470NF 10% 50V	5322 121 41965
548,549	CAPACITOR, CERAM 22NF 80% 63V	5322 122 31795
551	CAP, ELECTROLYT. 22UF 50% 25V	4822 124 20698
552,553	CAPACITOR, CERAM 22NF 80% 63V	5322 122 31795
554	CAPACITOR, FOIL 470NF 10% 50V	5322 121 41965
556	CAPACITOR, FOIL 160NF 1% 63V	5322 121 54116
557-562	CAPACITOR, CERAM 22NF 80% 63V	5322 122 31795
563	CAPACITOR, CERAM 100NF 10% 50V	5322 122 32002
569,578	CAPACITOR, FOIL 100NF 10% 100V	5322 121 40323
570,573	CAP, ELECTROLYT. 2200UF 50% 40V	4822 124 20797
571,574	CAP, ELECTROLYT. 1UF 50% 63V	4822 124 20722
572,576	CAP, ELECTROLYT. 22UF 50% 25V	4822 124 20698

ITEM	DESCRIPTION				ORDERING CODE
577,582	CAPACITOR,CERAM	22NF	80%	63V	5322 122 31795
579	CAP,ELECTROLYT.	4700UF	50%	16V	4822 124 20782
581	CAP,ELECTROLYT.	1UF	50%	63V	4822 124 20722
585	CAPACITOR,PAPER	47NF	10%	250V	5322 121 44138
586	CAPACITOR,FOIL	0,025UF	20%	250V	5322 121 41964
587-590	CAPACITOR,CERAM	2,2NF	10%	100V	4822 122 30114
591,592	CAPACITOR,CERAM	22NF	80%	63V	5322 122 31795
<u>RESISTORS/U1</u>					
638	POTM,CARBON	10K	LIN	0,1W	4822 101 20441
639	RESISTOR,HT	10M	5%	0,25W	4822 110 72214
651,662	RESISTOR,M.FILM	4K02	0,05%	0,125W	5322 116 52135
652,661	RESISTOR,M.FILM	402R	0,05%	0,125W	5322 116 52134
654,665	RESISTOR,M.FILM	4K42	0,1%	0,1W	5322 116 54186
657,658	RESISTOR,M.FILM	9K09	0,1%	0,1W	5322 116 55081
659	RESISTOR,M.FILM	4K02	0,1%	0,1W	5322 116 54283
663	RESISTOR,M.FILM	40K2	0,05%	0,125W	5322 116 52136
665	RESISTOR	NETW.4X47K	5%	0,125W	5322 116 60189
723,727	POTM,TRIMMING	100E	CARB LIN	0,1W	4822 100 10075
731	RESISTOR,M.FILM	1M	0,5%	0,5W	4822 116 51279 * S
<u>CRYSTAL/U1</u>					
850	CRYSTAL	16MHZ	HC-18/U		5322 242 70739
<u>UNIT 2</u>					
<u>INTEGRATED CIRCUITS/U2</u>					
351	INTEGR.CIRCUIT	PCE2111P			5322 209 81879
352	INTEGR.CIRCUIT	HEF4028BD			4822 209 10301
353,354	INTEGR.CIRCUIT	SN74LS05N			5322 209 84994
355,356	INTEGR.CIRCUIT	HEF4516BP			5322 209 14561
357	INTEGR.CIRCUIT	HEF4011BD			4822 209 10247
358	INTEGR.CIRCUIT	HEF4528BD			4822 209 10277
<u>DIODES/U2</u>					
450-458	LED	CQY54			4822 130 30914
<u>CAPACITORS/U2</u>					
593,600	CAP,ELEC.TANTAL	4,7UF	20%	25V	5322 124 14064
594,595	CAPACITOR,CERAM	2,2NF	10%	100V	4822 122 30114
596,597	CAP,ELEC.TANTAL	4,7UF	20%	25V	5322 124 14064
598	CAPACITOR,CERAM	100NF	10%	50V	5322 122 30108
599	CAPACITOR,CERAM	680PF	10%	100V	5322 122 32052
<u>DISPLAY/U2</u>					
855	DISPLAY	HAMLIN-LCD4847-313			5322 130 90157

LACQUERED METAL FILM RESISTORS MR25

style	resistance range	tol. ±%	series	temperature coefficient ±ppm/°C	limiting voltage (r.m.s.) V	service code no. 5322 116 5.... followed by
MR 25	4,99 Ω – 301 kΩ	1	E96	50 *	250	

* For resistance values lower than 49,9 Ω: 100 ppm/°C.

4,99	0568	16,5	4109	54,9	4445	182	4493	604	4528
5,11	4192	16,9	0627	56,2	4446	187	4494	619	4529
5,23	4113	17,4	4432	57,6	4447	191	4495	634	4531
5,36	4239	17,8	0418	59	4448	196	0676	649	4532
5,49	4102	18,2	4083	60,4	4449	200	4496	665	4533
5,62	4128	18,7	0895	61,9	4451	205	0669	681	4534
5,76	4413	19,1	4104	63,4	4375	210	4036	698	4037
5,90	1064	19,6	0473	64,9	4453	215	0457	715	0571
6,04	4114	20	1048	66,5	4454	221	4002	732	4535
6,19	1049	20,5	0678	68,1	4455	226	4497	750	4536
6,34	0862	21	4433	69,8	4456	232	4498	768	4537
6,49	4112	21,5	0677	71,5	4457	237	0679	787	4538
6,65	4414	22,1	0983	73,2	4458	243	0437	806	4539
6,81	4013	22,6	0491	75	4459	249	4499	825	4541
6,98	4103	23,2	4434	76,8	0494	255	4501	845	4542
7,15	4415	23,7	4014	78,7	0578	261	4502	866	4543
7,32	4416	24,3	4435	80,6	4461	267	4503	887	4544
7,50	4417	24,9	0903	82,5	4462	274	4504	909	4545
7,68	4418	25,5	4436	84,5	4463	280	4505	931	4546
7,87	4046	26,1	0876	86,6	4464	287	4506	953	4547
8,06	4419	26,7	4067	88,7	4465	294	4507	976	4548
8,25	4099	27,4	0493	90,9	4466	301	4508	1 K	4549
8,45	4421	28	0623	93,1	4467	309	4509	1 K02	4551
8,66	1051	28,7	4068	95,3	0569	316	4511	1 K05	4552
8,87	4101	29,4	4084	97,6	4468	324	4512	1 K07	4553
9,09	0863	30,1	0904	100	4469	332	4513	1 K1	4554
9,31	4422	30,9	4437	102	4471	340	4514	1 K13	4555
9,53	4258	31,6	4034	105	4472	348	4515	1 K15	0415
9,76	4423	32,4	4105	107	4473	357	0603	1 K18	4556
10	0452	33,2	0527	110	4474	365	4516	1 K21	4557
10,2	4111	34	4438	113	4475	374	4517	1 K24	4559
10,5	4071	34,8	4027	115	4476	383	4518	1 K27	0555
10,7	4424	35,7	4439	118	4477	392	4006	1 K3	0526
11	4059	36,5	0409	121	4426	402	4519	1 K33	4561
11,3	4425	37,4	4158	124	4478	412	4521	1 K37	0528
11,5	0838	38,3	0954	127	4479	422	0459	1 K4	4562
11,8	0738	39,2	4087	130	4481	432	4522	1 K43	4563
12,1	4069	40,2	0926	133	4482	442	0592	1 K47	0535
12,4	4427	41,2	4108	137	4483	453	4523	1 K5	4564
12,7	4261	42,2	1052	140	4484	464	0536	1 K54	0586
13	4082	43,2	0519	143	4485	475	4007	1 K58	0522
13,3	1047	44,2	0818	147	0766	487	0508	1 K62	4565
13,7	4428	45,3	0795	150	4486	499	4524	1 K65	4566
14	0839	46,4	0492	154	0506	511	4525	1 K69	4567
14,3	4429	47,5	0952	158	4487	523	4526	1 K74	0529
14,7	0412	48,7	0511	162	0417	536	0621	1 K78	5015
15	0902	49,9	4441	165	4488	549	0732	1 K82	4568
15,4	0925	51,1	4442	169	4489	562	4009	1 K87	0528
15,8	0861	52,3	4443	174	4491	576	4527	1 K91	4569
16,2	4431	53,6	4444	178	4492	590	0561	1 K96	4571

2K	4572	6K65	4604	22K1	4003	73K2	0666	243K	4733
2K05	0664	6K81	4012	22K6	0481	75K	4686	249K	4734
2K1	4573	6K98	4605	23K2	4645	76K8	4687	255K	4735
2K15	0767	7K15	4606	23K7	4646	78K7	0533	261K	4736
2K21	4574	7K32	4607	24K3	4647	80K6	4688	267K	4737
2K26	0675	7K5	4608	24K9	4648	82K5	4689	274K	4738
2K32	4575	7K68	4609	25K5	4649	84K5	4691	280K	4739
2K37	4576	7K87	0458	26K1	4651	86K6	4692	287K	4741
2K43	4004	8K06	4611	26K1	4652	88K7	4693	294K	4742
2K49	0581	8K25	4558	27K4	0559	90K9	4694	301K	4743
2K55	4577	8K45	4612	28K	0667	93K1	4297	316 K	5268
2K61	0671	8K66	4613	28K7	4653	95K3	0567	332 K	1184*
2K67	4578	8K87	4614	29K4	4654	97K6	4695	348 K	5499
2K74	0636	9K09	4615	30K1	4655	100K	4696	365 K	5641
2K8	4579	9K31	4616	30K9	4656	102K	4697	374 K	5457
2K87	0414	9K53	4617	31K6	4657	105K	4698	383 K	5335
2K94	4581	9K76	4618	32K4	4658	107K	4699	402 K	5283
3K01	0524	10K	4619	33K2	0482	110K	4701	412 K	5424
3K09	4582	10K2	4621	34K	4659	113K	4702	422 K	5247
3K16	0579	10K5	0731	34K8	4661	115K	4279	442 K	5458
3K24	4583	10K7	4622	35K7	4662	118K	4703	464 K	5207
3K32	4005	11K	4623	36K5	0726	121K	4704	475 K	1275
3K4	4584	11K3	0668	37K4	4663	124K	4705	499 K	5468
3K48	4585	11K5	4624	38K3	0483	127K	4706	511 K	5258
3K57	4586	11K8	4625	39K2	4664	130K	4707	536 K	4758
3K65	4587	12K1	0572	40K2	4665	133K	4708	562 K	1169
3K74	4588	12K4	4626	41K2	4666	137K	4709	590 K	5567
3K83	4589	12K7	0443	42K2	0474	140K	4259	619 K	5315
3K92	4591	13K	0522	43K2	4667	143K	4711	649 K	5331
4K02	4592	13K3	4627	44K2	4668	147K	4712	681 K	5284
4K12	4593	13K7	4628	45K3	4669	150K	4713	750 K	5532
4K22	0729	14K	4629	46K4	0557	154K	4714	806 K	1369
4K32	4594	14K3	4631	47K5	4671	158K	4715	825 K	1398
4K42	0556	14K7	4632	48K7	0442	162K	4716	866 K	1395
4K53	0631	15K	4001	49K9	0674	165K	4717	909 K	5533
4K64	0484	15K4	0479	51K1	0672	169K	4718	953 K	1368
4K75	4008	15K8	4633	52K3	4673	174K	4719	1MAO	5535
4K87	0509	16K2	0593	53K6	4674	178K	4721		
4K99	0523	16K5	4634	54K9	4675	182K	4722		
5K11	4595	16K9	4635	56K2	4676	187K	4723		
5K23	4596	17K4	4636	57K6	4677	191K	4724		
5K36	4597	17K8	4637	59K	4678	196K	4725		
5K49	4598	18K2	4638	60K4	4679	200K	4726		
5K62	4011	18K7	0558	61K9	0872	205K	4727		
5K76	4599	19K1	4639	63K4	4681	210K	4208		
5K9	0583	19K6	4641	64K9	0514	215K	4728		
6K04	4601	20K	4642	66K5	4682	221K	4038		
6K19	0608	20K5	4643	68K1	4683	226K	4729		
6K34	4602	21K	4644	69K8	4684	232K	4731		
6K49	4603	21K5	0451	71K5	4685	237K	4732		

* 4822 116 5....

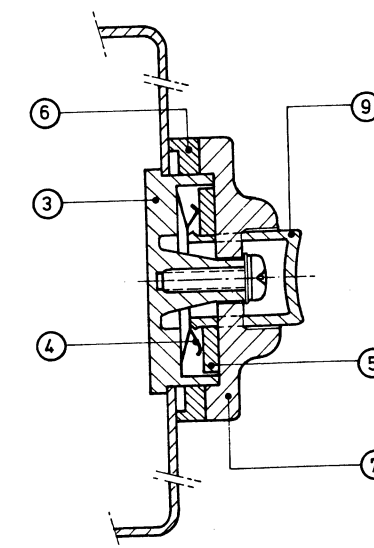

Fig. 15 Handle: spare parts

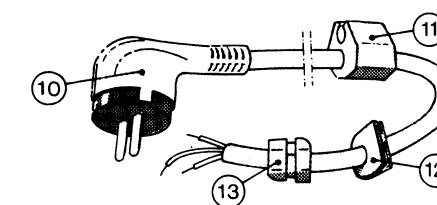
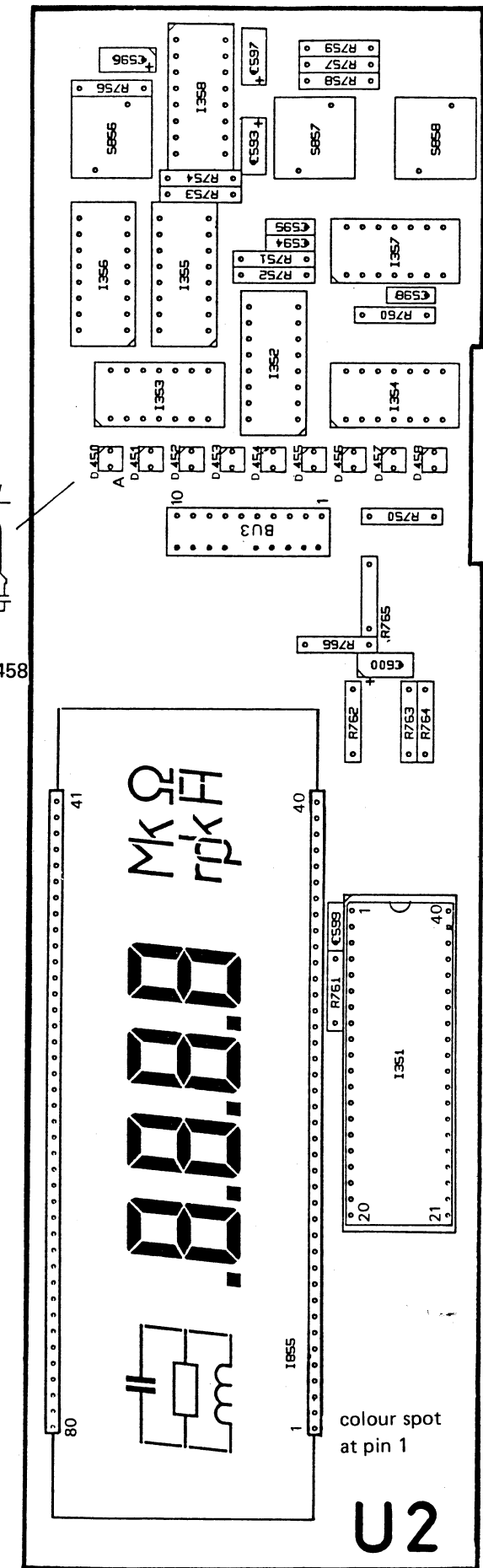
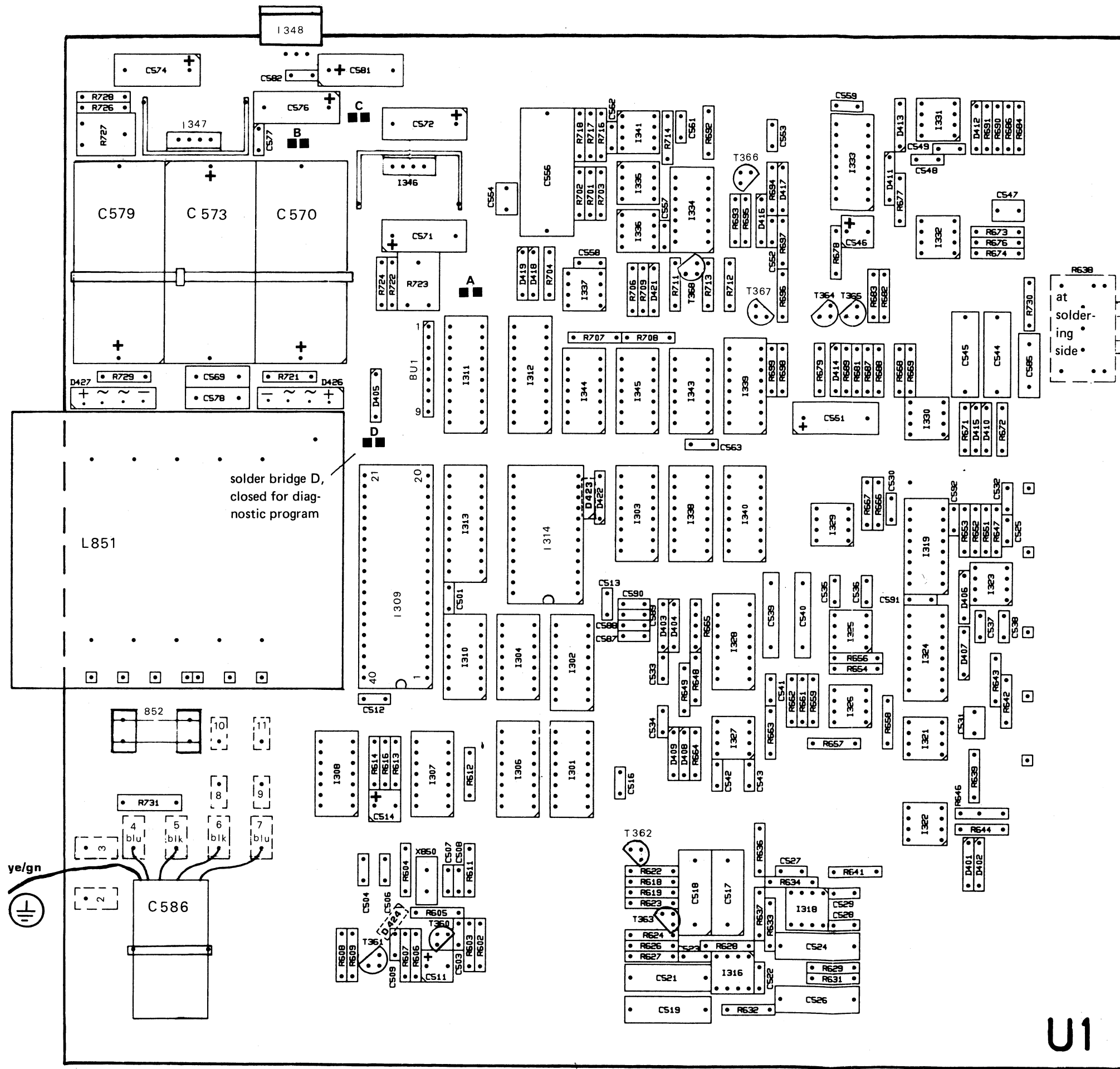
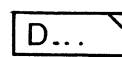
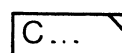
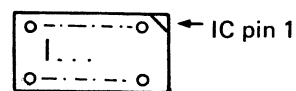

Fig. 16 Mains cable: spare parts



Symbol identification:



C... ← + pole electrolytic capacitor

D... ← cathode diode/LED

Fig. 17 Unit 1, Unit 2: component layout

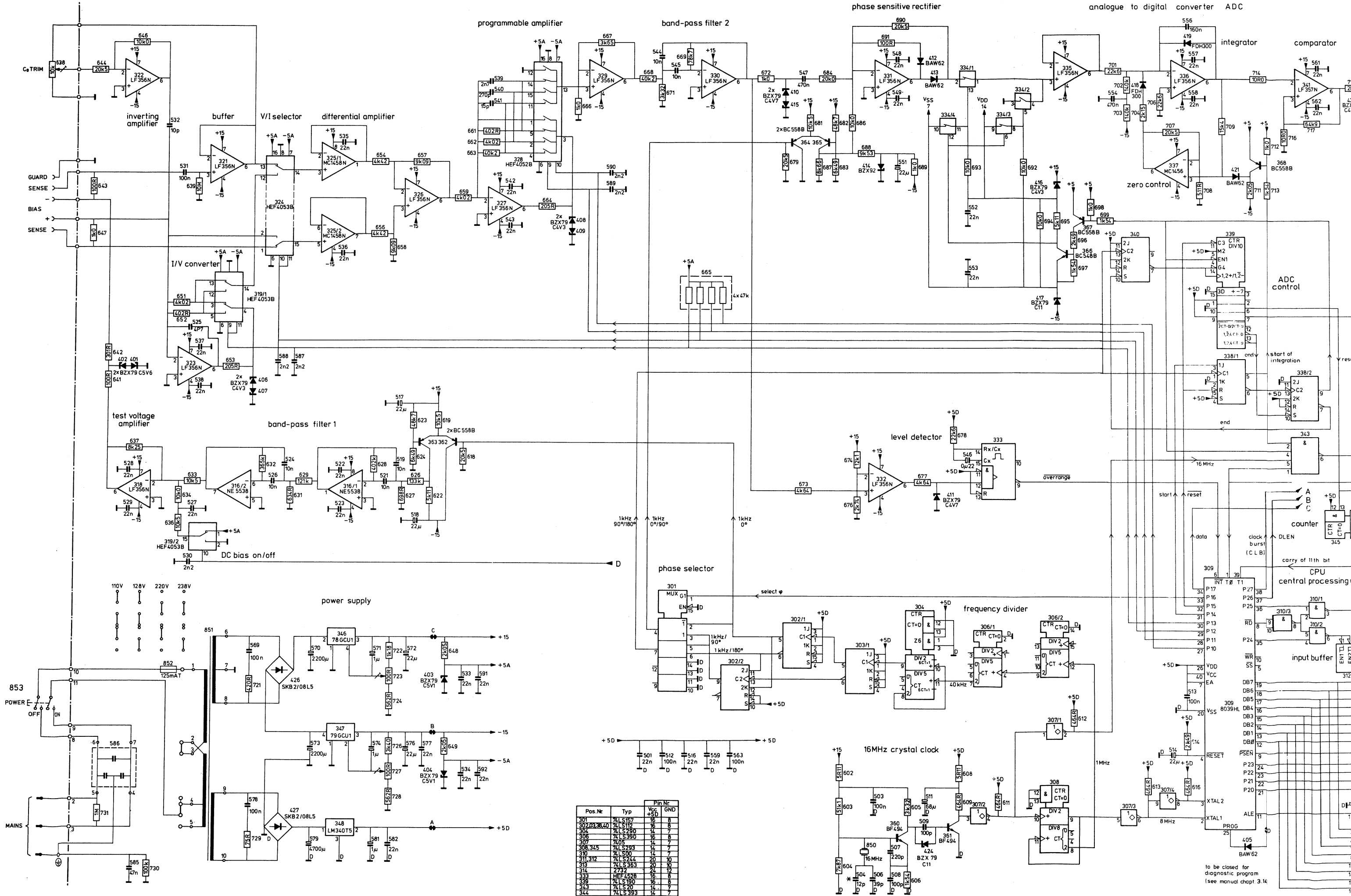

Pos. No	Typ	Pin No	Vcc	GND
301	74LS157	16	8	
302, 303, 304	74LS112	16	8	
304	74LS290	14	7	
306	74LS390	16	8	
307	7405	14	7	
308, 345	74LS293	14	7	
310	74LS00	14	7	
311, 312	74LS244	20	10	
313	74LS363	20	10	
314	2737	24	12	
319	HEF4528	16	8	
339	74LS190	16	8	
343	74LS20	14	7	
344	74LS393	14	7	

to be closed for diagnostic program (see manual chapt 3.14)

* may be altered in test

