

# Automatic RMS Multimeter PM2528

## Repair by Signature Analysis

Instruction Manual

9499 473 00211  
830304

---

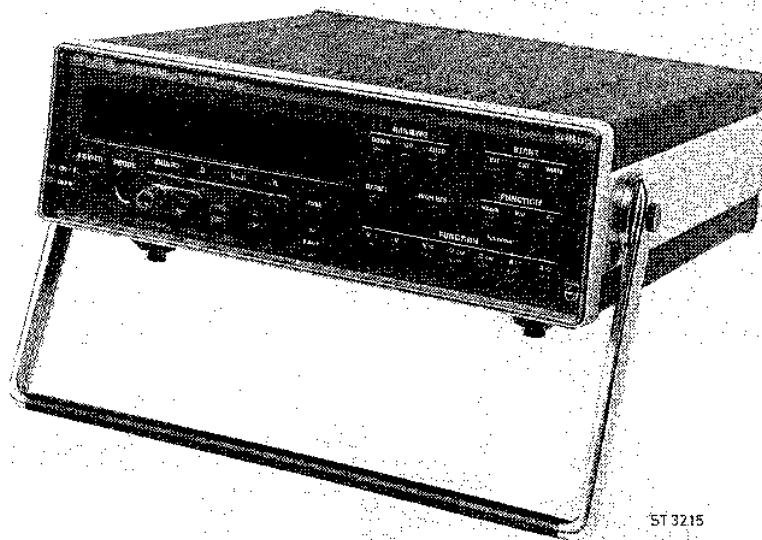

# PHILIPS

© PHILIPS EXPORT B.V. - EINDHOVEN - THE NETHERLANDS - 1983

PRINTED IN THE NETHERLANDS

## CONTENTS

Page

|        |   |      |    |    |
|--------|---|------|----|----|
| 1.     | General   |      |    | 1  |
| 2.     | Why use a signature analyser                                      |      |    | 1  |
| 3.     | Check with a signature analyser                                   |      |    | 1  |
| 4.     | Type of a signature analyser to be used                           |      |    | 1  |
| 5.     | Brief description of the tests                                    |      |    | 2  |
| 6.     | How to use the documentation and the testrom                      |      |    | 3  |
| 7.     | Fault-finding hints   |      |    | 3  |
| 8.     | How to order the signature analysis testrom and the documentation |      |    | 3  |
| 9.     | Additional equipment to be used                                   |      |    | 3  |
| 10.    | Fault-finding flow-chart  |      |    | 4  |
| 11.    | Testing the PM 2528   |      |    | 5  |
| 11.1.  | Test switch   |      |    | 5  |
| 11.2.  | Free run test   |      |    | 6  |
| 11.3.  | Ram and I/O test ( $\mu$ p)                                       | test | 0  | 9  |
| 11.4.  | Visual display/keyboard test                                      | test | 1  | 11 |
| 11.5.  | Display/keyboard led's test                                       | test | 2  | 12 |
| 11.6.  | Key test  | test | 3  | 16 |
| 11.7.  | Analog control test   | test | 4  | 20 |
| 11.8.  | Synchronous mains/adc start circuit test                          | test | 5  | 24 |
| 11.9.  | Interrupt controller test   | test | 6  | 26 |
| 11.10. | Galvanic separation test  | test | 7  | 30 |
| 11.11. | BCD output PM 9292, start $\overline{\text{DVM}}$ test            | test | 8  | 32 |
| 11.12. | BCD output PM 9292 test   | test | 9  | 36 |
| 11.13. | Analog output PM 9254 test  | test | 10 | 40 |
| 11.14. | IEC-BUS PM 9291 test  | test | 11 | 45 |



## REPAIR BY SIGNATURE ANALYSIS

### 1. GENERAL

For repair by signature analysis a testrom has been developed.

This testrom enables the user to test the digital part of the PM2528 by means of signature analysis.

It also enables trouble-shooting at component level in the circuit under test, by comparing the actual signature to the correct one. So the trouble-shooter can trace back the faulty node.

In total there are 13 tests. In the testrom 12 tests have been implemented and one test is made with the help of the free run facility of the PM2528.

### 2. WHY USE A SIGNATURE ANALYSER?

Thanks to the microcomputer in the digital part of the PM2528 the instrument can be very small.

Due to this the bus structure is very complex. Data flow on the bus becomes complex and cannot be analysed with an oscilloscope and voltmeter any longer. Therefore the need to test and service the digital part is acute.

The trouble-shooting involves the detection of circuit failure and the localization of faults at the source.

Finding the fault source in a bus system, such as the bus in the PM2528, with complex feedbacks can be difficult. But opening the feedback paths and using the signature analyser makes fault-finding easy.

### 3. CHECK WITH A SIGNATURE ANALYSER

The signature analyser checks the digital part of the PM2528 by detecting the bit stream at various circuits nodes, and displaying them as hexadecimal signatures.

To do this the PM2528 supplies the signature analyser with three gating signals, or in some cases four:

START, STOP, CLOCK and QUALIFIER.

START signals the beginning of a measurement and prepares the signature analyser to receive information from the data probe. STOP closes does this measurement. In cases of measuring signatures with RC delays, a QUALIFIER has to be used to stop the incoming information for a short period of time. The CLOCK is the system clock of the PM2528 under test to accept the data synchronously.

*NOTE: The active edge of each of these gating signals must be selectable.*

### 4. TYPE OF SIGNATURE ANALYSER TO BE USED?

The signature analyser to be used in combination with the PM2528 should have the following capabilities:

- Selectable edges of; START, STOP, CLOCK and QUALIFIER.
- Signatures in the following sequence:

| DIGIT | DISPLAY | DIGIT | DISPLAY |
|-------|---------|-------|---------|
| 0000  | 0       | 1000  | 8       |
| 0001  | 1       | 1001  | 9       |
| 0010  | 2       | 1010  | A       |
| 0011  | 3       | 1011  | C       |
| 0100  | 4       | 1100  | F       |
| 0101  | 5       | 1101  | H       |
| 0110  | 6       | 1110  | P       |
| 0111  | 7       | 1111  | U       |

## 5. BRIEF DESCRIPTION OF THE TESTS

### FREE RUN TEST

With this test it is possible to measure signatures on the address latches and the data bus of the microcomputer. This is necessary to check if the data can be taken from the testrom.

### TEST 0 (Ram and I/O test of the $\mu$ p)

This test checks the internal RAM of the microcomputer. When the RAM is correct, it will also test the I/O parts of the microcomputer. Only then can signatures be measured on the I/O parts databus and ROM.

### TEST 1 (Visual display/keyboard leds test)

This test fills the display leds and keyboard leds with a certain pattern. In this way a quick display/keyboard test can be made.

### TEST 2 (Display/keyboard leds test)

This test sends signatures to the display and keyboard. The decoding, the 7-segment leds and the key-leds are tested.

### TEST 3 (Key test)

This test sends signatures to the keys and reads them back.

### TEST 4 (Analog control test)

This test activates the I/O expanders and the relays in the analog section.

### TEST 5 (Synchronous mains/adc start circuit test, no S.A.)

This test checks the following signals:

- Synchronous mains/adc start circuit
- Watchdog
- ADC test switch

The  $\mu$ p reads these signals and if correct an indication will be displayed.

### TEST 6 (Interrupt controller test no S.A.)

This test checks the following signals:

- Watchdog interrupt
- Interrupt from keyboard
- External start interrupt

The  $\mu$ p reads these signals and if correct an indication will be displayed.

### TEST 7 (Galvanic separation test)

This test sends signatures to the galvanic separation. Before the interfaces are tested this unit should be tested first.

### TEST 8 (BCD output PM9292, start $\overline{\text{DVM}}$ test, no S.A.)

This test checks the start  $\overline{\text{DVM}}$  (digital voltmeter) signal. The  $\mu$ p will read this signal and if correct an indication will be displayed.

**TEST 9 (BCD output PM9292 test)**

This test checks the complete BCD output.

**TEST 10 (Analog output PM9254 test)**

This test checks the complete analog output.

**TEST 11 (IEC-BUS PM9292 test)**

This test checks the complete IEC-BUS interface.

**6. HOW TO USE THE DOCUMENTATION AND THE TESTROM**

This service manual should be used in combination with the service manual of the PM2528. The user of the fault-finding procedure in the PM2528 service manual will be directed to a certain part of the PM2528.

If the fault-finding procedure does not solve the problem, then select a signature analysis test which is associated with the part of the PM2528.

Begin always with the microcomputer, or with the inputs of the integrated circuits, and try to find the faulty node. Bear in mind that when the faulty node has been found, more than one circuit can cause the faulty signature.

**7. FAULT-FINDING HINTS**

The first thing to do is to get an analysis of what is wrong. If this is not possible get the PM2528 in the free run mode by breaking the bus system between the microcomputer and the ROMs. This is done by removing the ROMs, and using the FREE-RUN simulator.

The microcomputer is now forcing—in some instruction that will cause a repeated increment of the address lines. So at this point the microcomputer is scanning the whole address field.

With START and STOP lines from the signature analyser, both connected to the most significant address bit and triggering on different edges, a measurement will be defined. Connecting the CLOCK line of the signature analyser to the  $\overline{\text{ALE}}$  signal of the microcomputer and selecting the edge at which the address is valid, the input probe will get a signature at every address line.

By touching the probe in every test to a logic 1 level, a characteristic signature is obtained. This is the result of shifting ones (logic 1) in for every cycle that occurs while the gate is open. So the characteristic signature can be used to diagnose this condition elsewhere. The logic 0 is always a signature of "0000". Assume there are no bad signatures in the free-run test, then the TESTROM can be placed in the D1810 socket and it is possible to start measuring with test 0.

If an incorrect part can be located with the fault-finding procedure it is recommended to start with the test which is responsible for that fixed part of the PM2528. To do this a special switch has to be used. (Refer to chapter 11.1. at this service manual).

**8. HOW TO ORDER THE SIGNATURE ANALYSIS TESTROM AND THE DOCUMENTATION**

Under ordering number 5322 694 54015 the testrom and the documentation can be ordered from Concern Service.

**9. ADDITIONAL EQUIPMENT TO BE USED**

1. Free run simulator (refer to chapter 5.4. of the PM2528 service manual)  
(Free run)
2. Test switch (refer to chapter 11.1. of this manual)  
(test 0 → 11)
3. Test ROM (ordering number 5322 694 54015)  
(test 0 → 11)
4. Two extender printed circuit boards (ordering number 4822 263 70117)

## 10. FAULT-FINDING FLOW CHART (refer to page 5.4. of the PM2528 service manual)

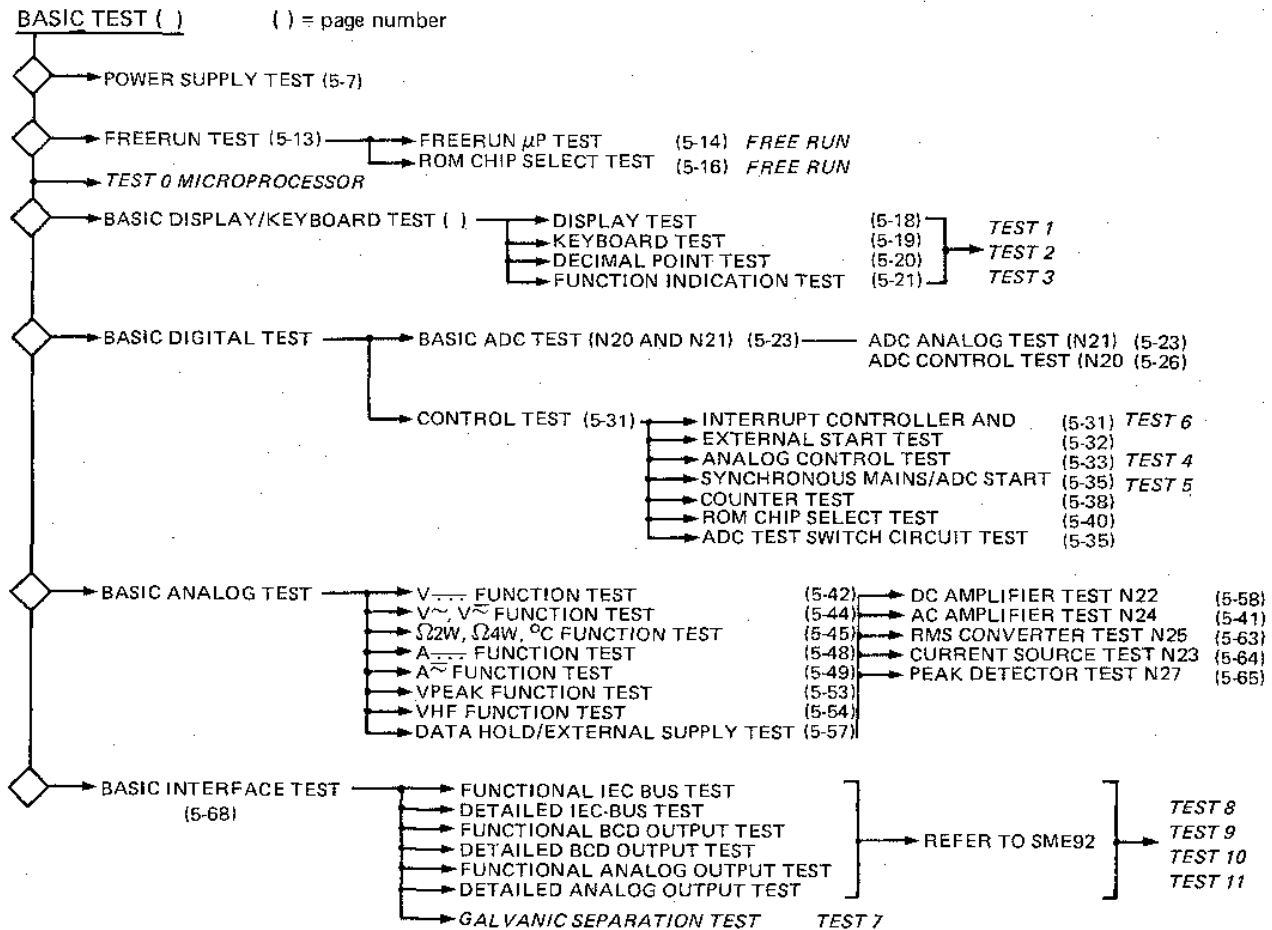

NOTE: THE TEST WRITTEN IN ITALICS ARE ADDITIONAL WHICH CAN BE CALLED WHEN USING THE SPECIAL TEST ROM



## 11. TESTING THE PM2528

### 11.1. Test switch

To switch from one test to another signal XC20 of the microcomputer has to be connected to logic zero (-5V) every time. However the XC20 input of the  $\mu p$  has no pull-up resistor. To ensure correct switching a pull-up simulator with e.g. pulse switch should be used. This may be done in the following way:

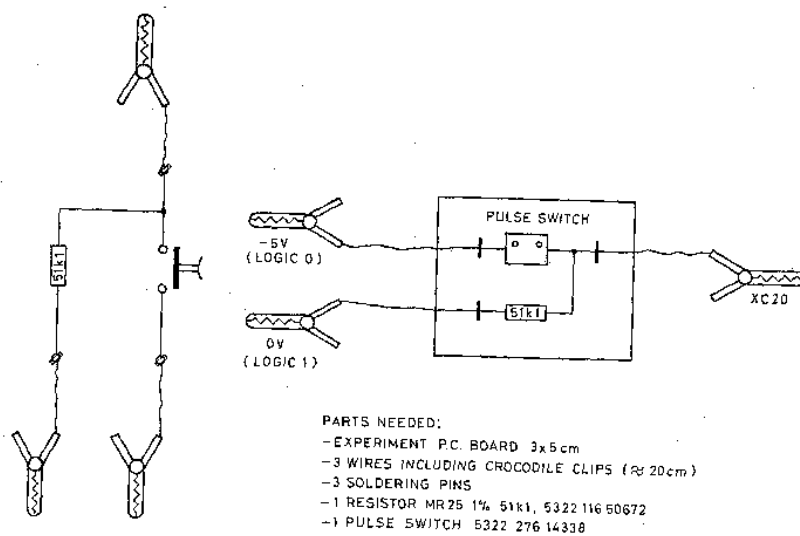



Before switching on the tests, connect the test switch to the PM2528.

- XC20 to test pin XC20
- 0V to test pin 0V (logic 1)
- 5V to test pin -5V (logic 0)

Switch on the PM2528 and select the desired test by pushing the pulse switch. Initial the PM2528 will jump to test 0.

## 11.2. Free run

Settings signature analyser

| Setting | Edge  | Test pin | Signal name |
|---------|---|----------|-------------|
| START   |  | D1810/1  | ROM / A7    |
| STOP    |  | D1810/1  | ROM / A7    |
| CLOCK   |  | TP ALE   | $\mu$ p/ALE |
| QUAL    | —   | —        |             |
| GROUND  | —   | TP -5V   | Logic 0     |

## Preparations

- PM2528
  - Free run simulator placed in D1810 socket (Both ROMs removed). Refer to 5.4. of the PM2528 service manual.
  - Analog control p.c.b. N20 removed.
  - Galvanic separation p.c.b. and interfaces (ANALOG, BCD, IEC) removed.
- Connect the signature analyser as given in the settings table.
- Switch on the PM2528.

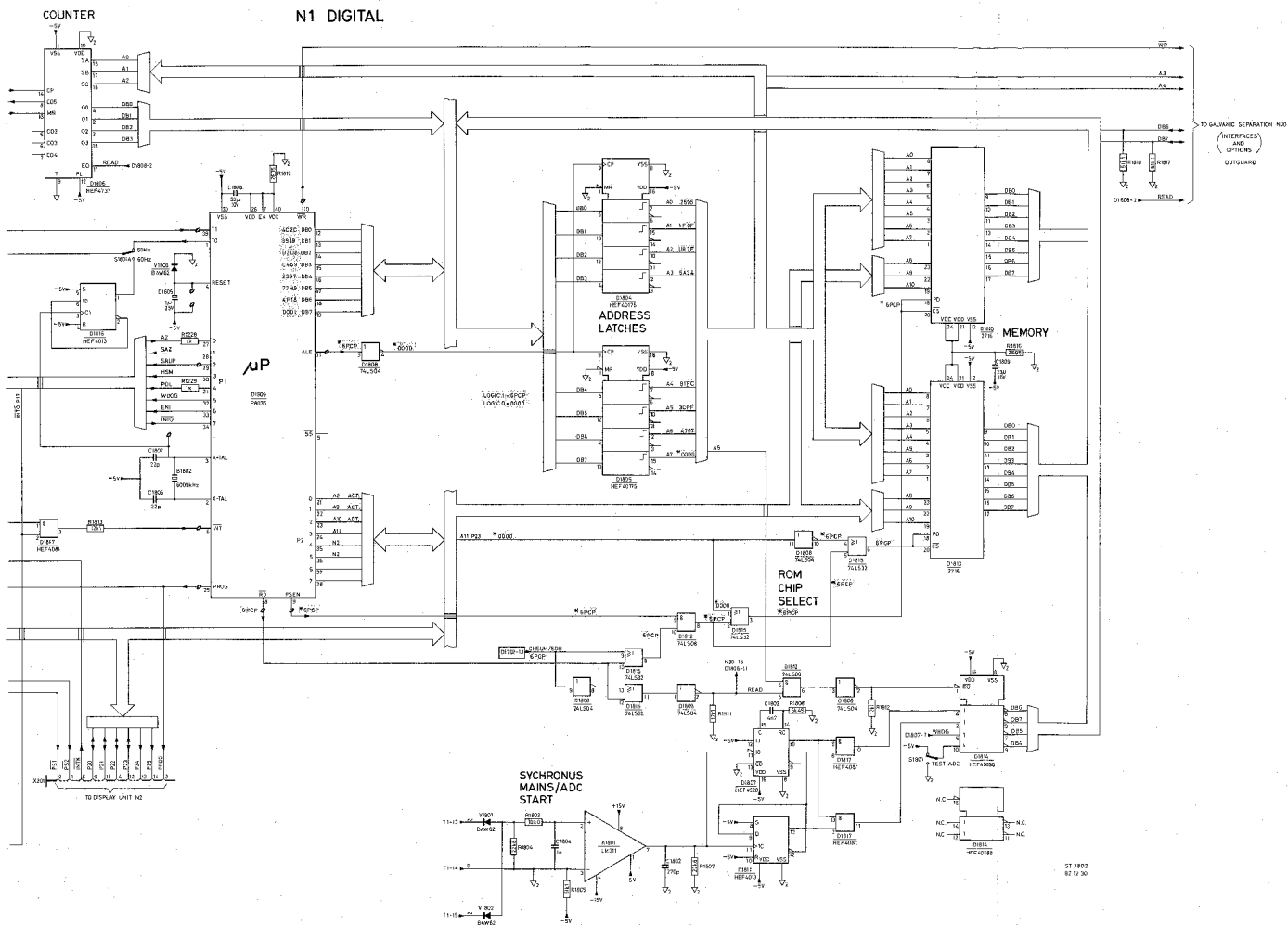

ST 2802  
82 12 30



#### 11.4. TEST 1 Visual display/keyboard (No S.A.)

##### Preparations



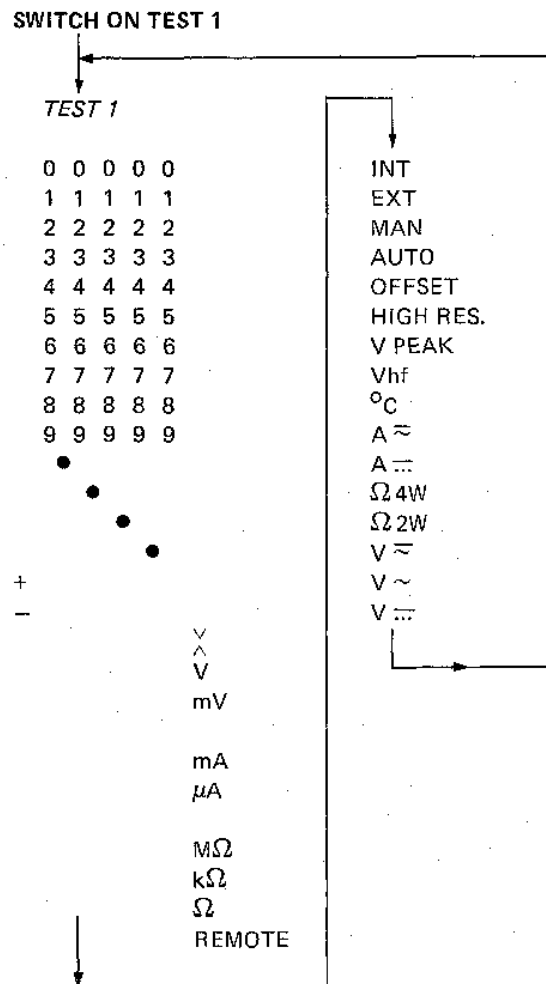

- PM2528
  - Testrom placed in D1810 socket (Both ROMs removed).
  - Analog control p.c.b. removed.
  - Galvanic separation p.c.b. and interface (ANALOG, BCD, IEC) removed.
- Connect the test switch to the PM2528 (refer to 11.1).
- Switch on the PM2528 and select TEST 1.

##### INDICATION



### 11.5. TEST 2 Display/keyboard leds test (+ QUALIFIER)

Setting signature analyser

| Setting | Edge  | Test pin | Signal name        |
|---------|---|----------|--------------------|
| START   |  | TP RUP   | $\mu$ p/P12 (SRUP) |
| STOP    |  | TP RUP   | $\mu$ p/P12 (SRUP) |
| CLOCK   |  | TP ALE   | $\mu$ p/ALE        |
| QUAL    |  | N20/12   | SAZ                |
| GROUND  | —   | TP -5V   | Logic 0            |

Preparations

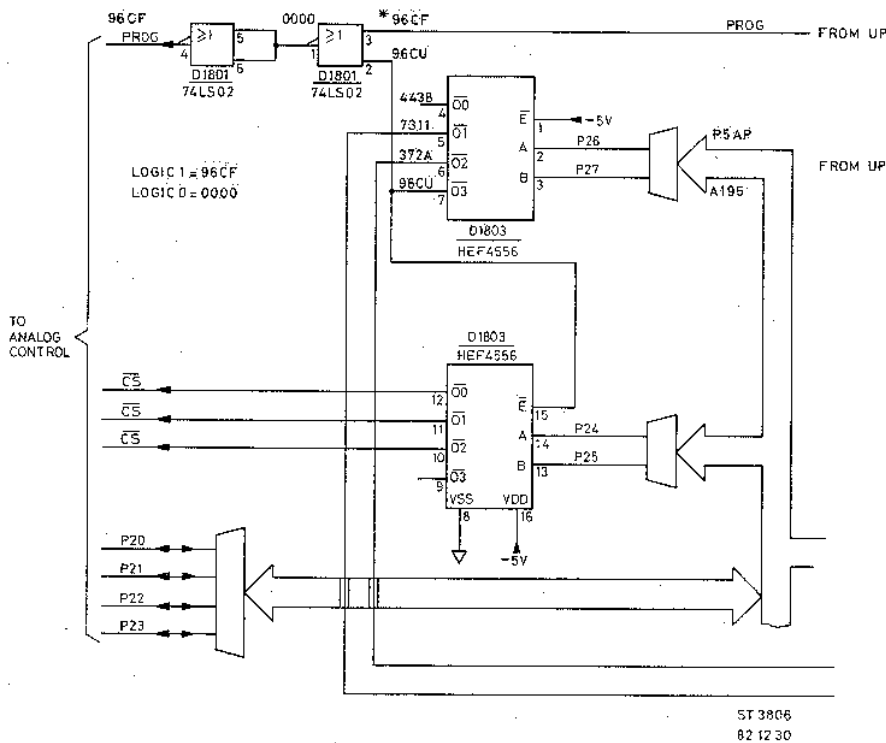

- PM2528
  - Testrom placed in D1810 socket (both ROMs removed).
  - Analog control p.c.b. removed and replaced by extender p.c.b.
  - Galvanic separation p.c.b. and interfaces (ANALOG, BCD, IEC) removed.
  - All analog units may be removed, it is not necessary.
- Connect the test switch to the PM2528 (refer to 11.1.).
- Connect the signature analyser as given in the settings table.
- Switch on the PM2528 and select *TEST 2*.





## 11.6. TEST 3 Keys

Settings signature alayser

| Settings | Edge  | Test pin | Signal name        |
|----------|---|----------|--------------------|
| START    |  | TP RUP   | $\mu$ P/P12 (SRUP) |
| STOP     |  | TP RUP   | $\mu$ P/P12 (SRUP) |
| CLOCK    |  | TP ALE   | $\mu$ P/ALE        |
| QUAL     | —   | —        | —                  |
| GROUND   | —   | TP -5V   | Logic 0            |

Preparations

- PM2528
  - Testrom placed in D1810 socket (both ROMs removed).
  - Analog control p.c.b. N20 removed.
  - Galvanic separation p.c.b. and interfaces (ANALOG, BCD, IEC) removed.
- Connect the test switch to the PM2528 (refer to 11.1.)
- Connect the signature analyser as given in the settings table.
- Switch on the PM2528 and select TEST 3.



N2 DISPLAY UNIT

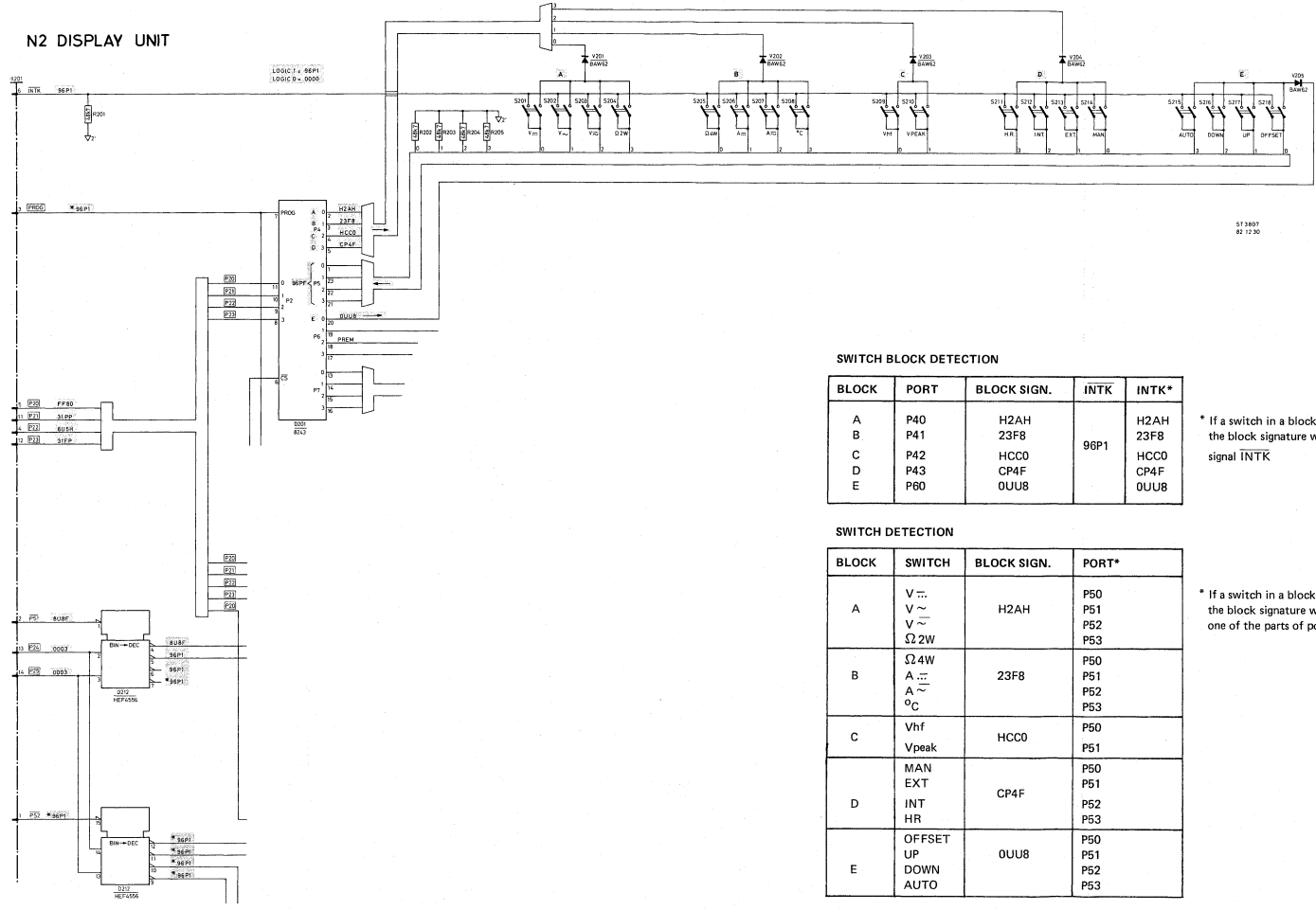

SWITCH BLOCK DETECTION

| BLOCK | PORT | BLOCK SIGN. | INTK | INTK* |
|-------|------|-------------|------|-------|
| A     | P40  | H2AH        |      | H2AH  |
| B     | P41  | 23F8        | 96P1 | 23F8  |
| C     | P42  | HCC0        |      | HCC0  |
| D     | P43  | CP4F        |      | CP4F  |
| E     | P60  | OUU8        |      | OUU8  |

\* If a switch in a block is depressed the block signature will appear on signal INTK





SWITCH DETECTION

| BLOCK | SWITCH                       | BLOCK SIGN. | PORT*                    |
|-------|------------------------------|-------------|--------------------------|
| A     | V ~<br>V ~<br>V ~<br>Ω 2W    | H2AH        | P50<br>P51<br>P52<br>P53 |
| B     | Ω 4W<br>A ~<br>A ~<br>Ω C    | 23F8        | P50<br>P51<br>P52<br>P53 |
| C     | Vhf<br>Vpeak                 | HCC0        | P50<br>P51               |
| D     | MAN<br>EXT<br>INT<br>HR      | CP4F        | P50<br>P51<br>P52<br>P53 |
| E     | OFFSET<br>UP<br>DOWN<br>AUTO | OUU8        | P50<br>P51<br>P52<br>P53 |

\* If a switch in a block is depressed the block signature will appear on one of the parts of part 5.

11.7. TEST 4 Analog control (+ QUALIFIER)

Settings signature analyser

| Setting | Edge  | Test pin | Signal name   |
|---------|---|----------|---------------|
| START   |  | TP RUP   | µp/P12 (SRUP) |
| STOP    |  | TP RUP   | µp/P12 (SRUP) |
| CLOCK   |  | TP ALE   | µp/ALE        |
| QUAL.   |  | N20/12   | SAZ           |
| GROUND  | -   | -5V      | Logic 0       |

Preparations

- PM2528
  - Testrom in D1810 socket (both ROMs removed).
  - Analog control p.c.b. N20 removed and replaced by extender p.c.b.
  - Galvanic separation p.c.b. and interfaces (ANALOG, BCD, IEC) removed.
  - Remove all plug-in units.
- Connect the test switch to the PM2528 (refer to 11.1.).
- Connect the signature analyser as given in the settings table.
- Switch on the PM2528 and select TEST 4.
- If test 4 is correct, place the current source N23, DC amplifier N22 HF voltage unit N26, RMS convertor N25 and peak detector N27 in the PM2528 again and trace back the signals on the units.

NOTE: Peak detector N27 (PM9259) and HF voltage unit (PM9258) are options.

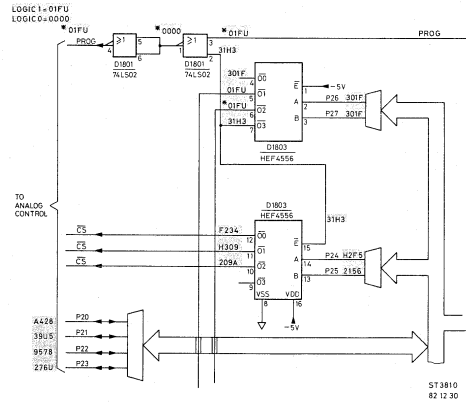





11.8. TEST 5 Synchronous mains/ADC start circuit

Preparations

- PM2528
  - Testrom placed in soc
  - Analog control p.c.b.
  - Galvanic separation p
- Connect the test switch to the PM2528 (refer
- Switch on the PM2528 and select TEST 5.
- Use a data probe or oscilloscope to measure t
  - Logic 1 = 0V, logic 0 = -5V.

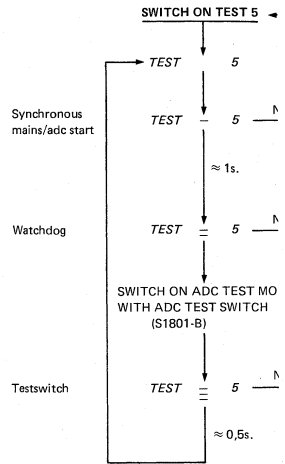

11.8. TEST 5 Synchronous mains/ADC start circuit (No S.A.)

Preparations

- PM2528
  - Testrom placed in socket D1810 (both ROMs removed).
  - Analog control p.c.b. N20 removed.
  - Galvanic separation p.c.b. and interfaces (BCD, ANALOG, IEC) removed.
- Connect the test switch to the PM2528 (refer to 11.1.).
- Switch on the PM2528 and select TEST 5.
- Use a data probe or oscilloscope to measure the state of the signals.  
Logic 1 = 0V, logic 0 = -5V.

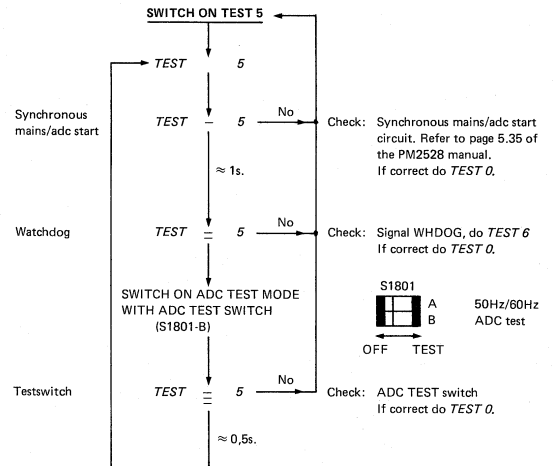

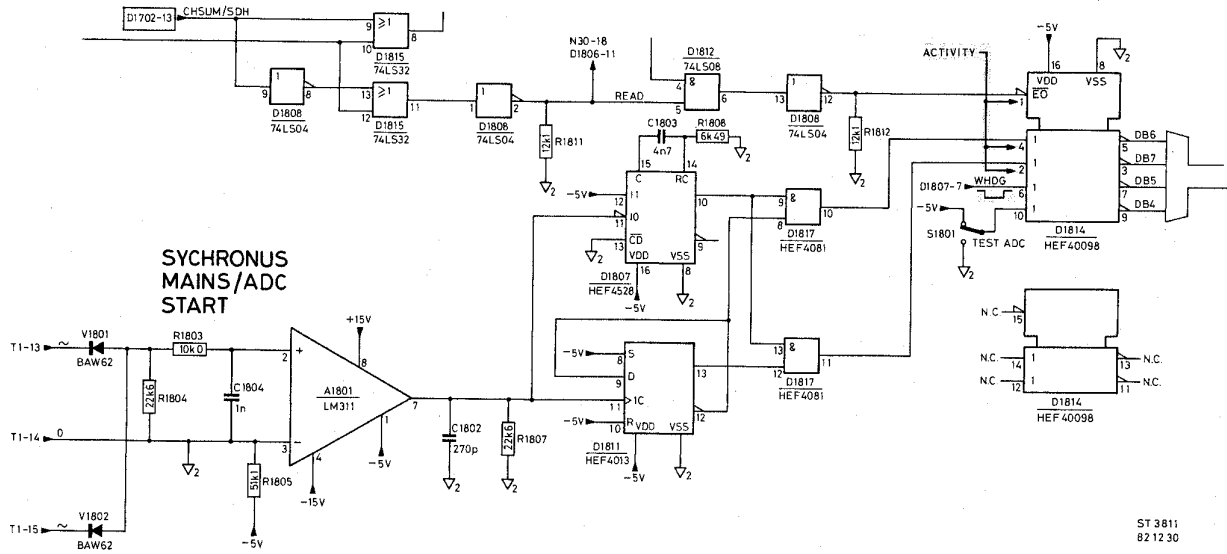

11.9. TEST 6 Interrupt controller (No S.A.)

Preparations

- PM2528
  - Testrom placed in D1810 socket (both ROMs removed).
  - Analog control p.c.b. N20 removed.
  - Galvanic separation p.c.b. and interfaces (BCD, ANALOG, IEC) removed.
- Connect the test switch to the PM2528 (refer to 11.1.).
- Switch on the PM2528 and select TEST 6.
- Use a data probe or oscilloscope to measure the state of the signals.  
Logic 1 = 0V, logic 0 = -5V.

INDICATION

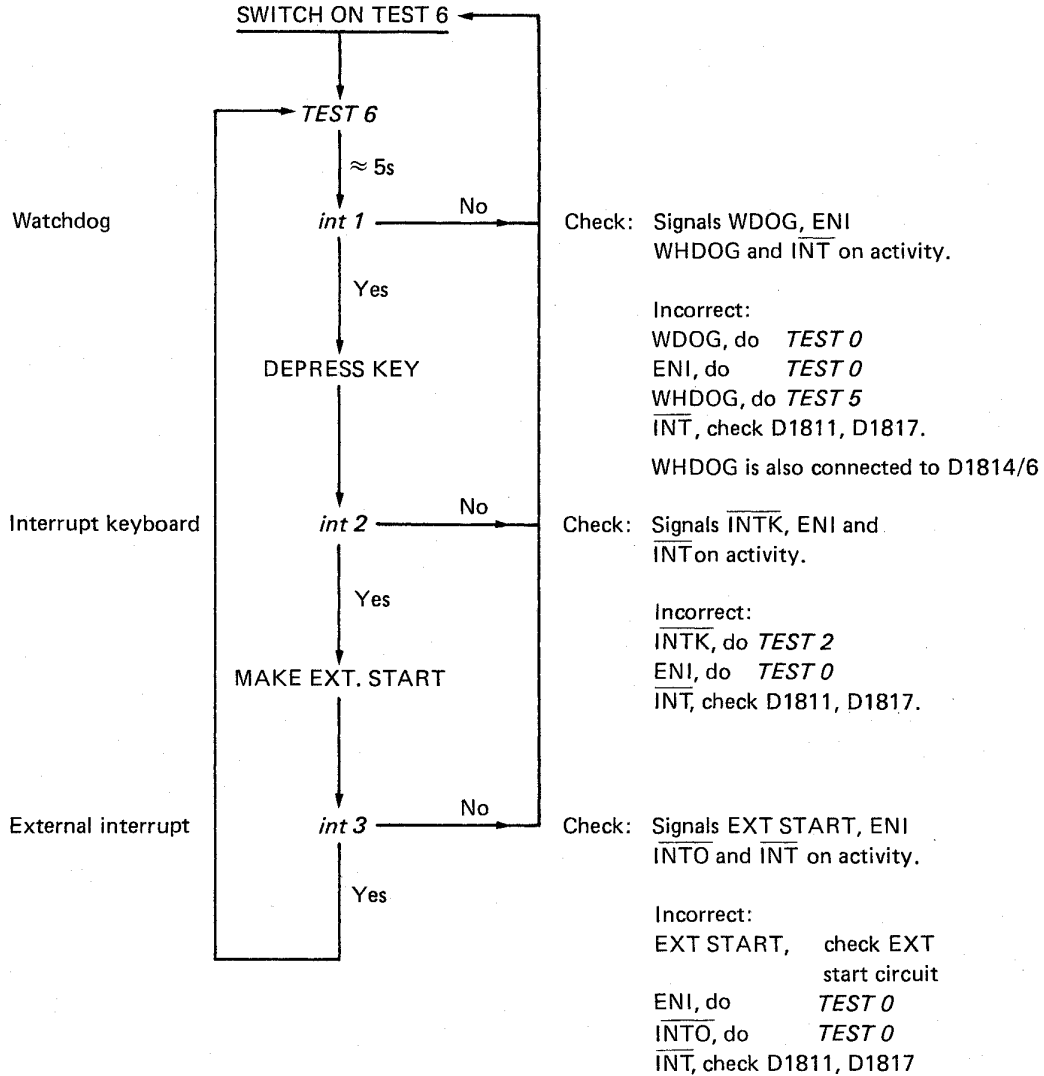



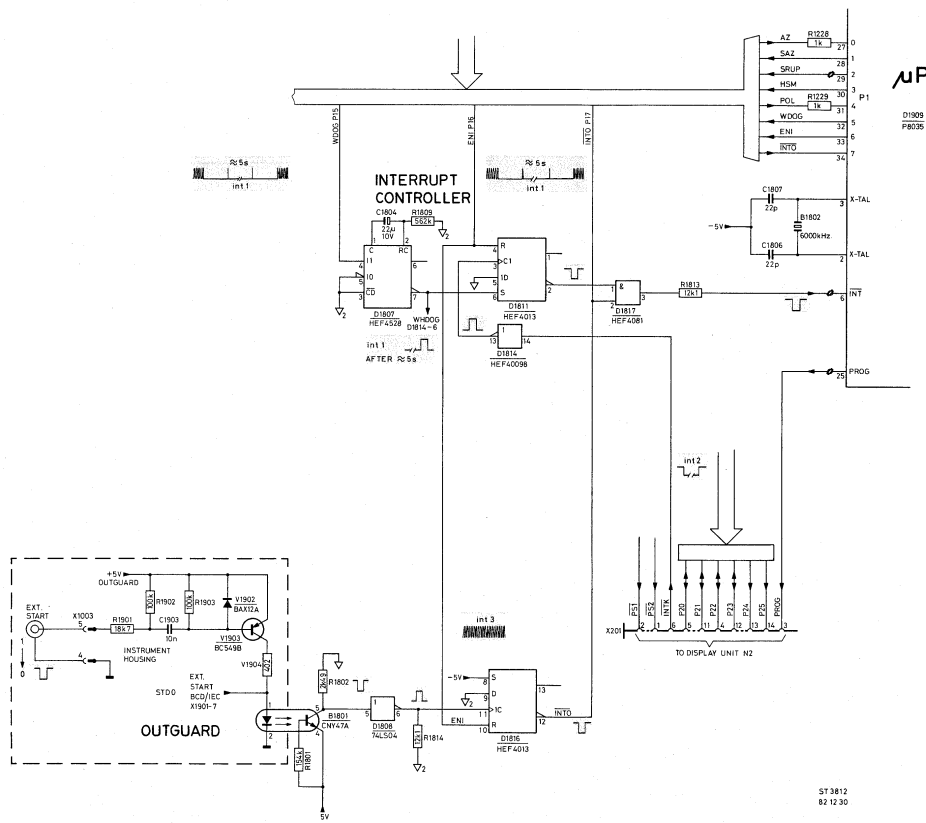



## 11.10. TEST 7 Galvanic separation

Setting signature analyser

| Setting | Edge  | Test pin | Signal name        |
|---------|---|----------|--------------------|
| START   |  | TP RUP   | $\mu$ P/P12 (SRUP) |
| STOP    |  | TP RUP   | $\mu$ P/P12 (SRUP) |
| CLOCK   |  | TP WR    | $\mu$ P/WR         |
| QUAL    | —   | —        | —                  |
| GROUND  | —   | TP -5V   | Logic 0            |

Preparations

- PM2528
  - Testrom placed in D1810 socket (both ROMs removed).
  - Analog control p.c.b. N20 removed and replaced by extender p.c.b.
  - Galvanic separation p.c.b. N30 placed on extender p.c.b.
  - Interconnect N30/12 to N30 (Galvanic separation).
- Connect the signature analyser to the PM2528 as given in the settings table.
- Connect the test switch to the PM2528 (refer to 11.1.).
- Switch on the PM2528 and select TEST 7.



### 11.11. TEST 8 BCD output PM9292, Start DVM (No S.A.)

#### Preparations

- PM2528
  - Test rom placed in D1810 socket (both ROMs removed).
  - Analog control p.c.b. N20 removed.
  - Galvanic separation p.c.b. N30 placed on extender p.c.b.
  - Interconnect N30/12 to N30/8 (Galvanic separation).
- Connect the test switch to the PM2528 (refer to 11.1.).
- Switch on the PM2528 and select test 8.
- Use a data probe or oscilloscope to measure the state of the signals.  
Logic 0 = -5V, logic 1 = 0V.

#### Indication

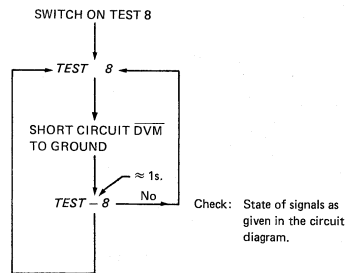

- If test 8 is switched on TEST 8 will appear on the display.
- Short circuit signal START DVM and ground, on the display a dash will appear between TEST and 8 for about 1 second (TEST - 8). This means that the  $\mu p$  has read the start dvm signal. If in-correct measure the state of the signals as given in the circuit diagram.

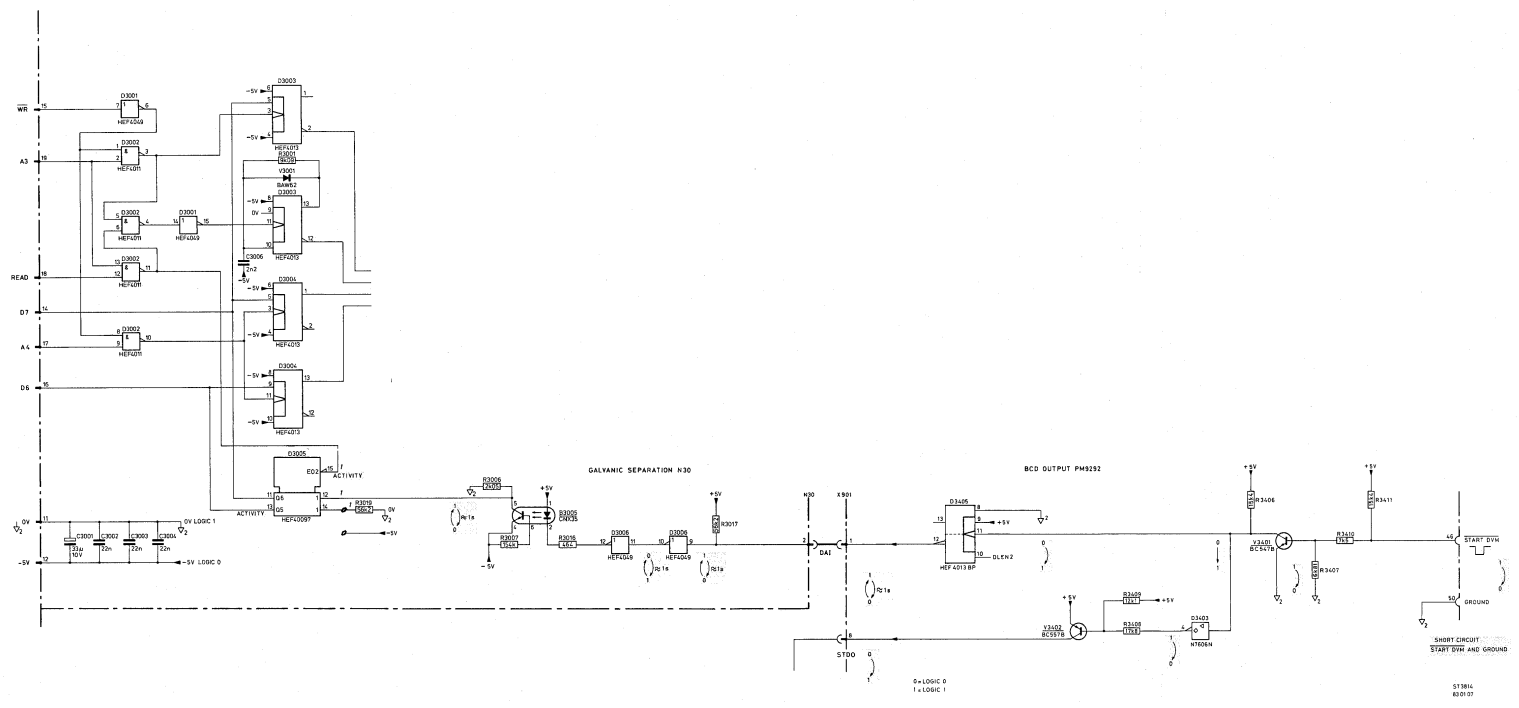



## 11.12. TEST 9 BCD output PM9292

Setting signature analyser

| Setting | Edge  | Test pin | Signal name                     |
|---------|---|----------|---------------------------------|
| START   |  | TP RUP   | $\mu\text{P}/\text{P12}$ (SRUP) |
| STOP    |  | TP RUP   | $\mu\text{P}/\text{P12}$ (SRUP) |
| CLOCK   |  | TP WR    | $\mu\text{P}/\text{WR}$         |
| QUAL    | —   | —        | —                               |
| GROUND  | —   | TP -5V   | Logic 0                         |



Preparations

- PM2528
  - Testrom placed in D1810 socket (both ROMs removed).
  - Analog control p.c.b. N20 removed.
  - Galvanic separation p.c.b. N30 placed on extender p.c.b.
  - Interconnect N30/12 to N30/8 (Galvanic separation).
- Connect the signature analyser to the PM2528 as given in the settings table.
- Connect the test switch to the PM2528 (refer to 11.1.).
- Switch on the PM2528 and select TEST 9.



## 11.13. TEST 10 Analog output PM9254

TEST10-A Input part.  
Settings signature analyser



| Setting | Edge  | Test pin | Signal name      |
|---------|---|----------|------------------|
| START   |  | TP RUP   | $\mu$ p/P12 SRUP |
| STOP    |  | TP RUP   | $\mu$ p/P12 SRUP |
| CLOCK   |  | TP WR    | $\mu$ p/WR       |
| QUAL    | —   | —        | —                |
| GROUND  | —   | TP -5V   | Logic 0          |

## Preparations

- PM2528
  - Testrom placed in D1810 socket (both ROMs removed).
  - Analog control p.c.b. N20 removed and replaced by extender p.c.b.
  - Galvanic separation p.c.b. N30 placed on extender p.c.b.
  - Interconnect N30/12 to N30/8 (Galvanic separation).
- PM9254
  - Set digit switch in position C (refer to rear of PM2528).
- Connect the signature analyser to the PM2528 as given in the settings table.
- Connect the test switch to the PM2528 (refer to 11.1.).
- Switch on the PM2528 and select TEST 10.

TEST 10-B Output part (Self running, with own clock).

Settings signature analyser

| Setting | Edge  | Test pin | Signal name |
|---------|---|----------|-------------|
| START   |  | D3111/3  | Load        |
| STOP    |  | D3111/3  | Load        |
| CLOCK   |  | TP3103   | Clock       |
| QUAL    | —   | —        | —           |
| GROUND  | —   | TP -5V   | Logic 0     |

## Preparations

- PM2528
  - Refer to test 10A.
- PM9254
  - Set the digit select switch in position A (refer to rear of the PM2528).
- Connect the signature analyser to the PM2528 as given in the settings table.
- Connect the test switch to the PM2528 (refer to 11.1.).
- Switch on the PM2528 and select TEST 10.









### 11.14. TEST 11 IEC-BUS PM9291 (without address decoder)

Settings signature analyser

| Setting | Edge  | Test pin | Signal name        |
|---------|---|----------|--------------------|
| START   |  | TP RUP   | $\mu$ p/P12 (SRUP) |
| STOP    |  | TP RUP   | $\mu$ p/P12 (SRUP) |
| CLOCK   |  | N20/12   | $\mu$ p/P10 AZ     |
| QUAL.   | —   | —        | —                  |
| GROUND  | —   | TP -5V   | Logic 0            |

Preparations

- PM2528
  - Testrom placed in D1810 socket (both ROMs removed).
  - Analog control p.c.b. N20 removed and replaced by extender p.c.b.
  - Galvanic separation p.c.b. N30 placed on extender p.c.b.
  - Inter-connect N30/12 to N30/8 (Galvanic separation).
- PM9291
  - Jumper on the interface in position test

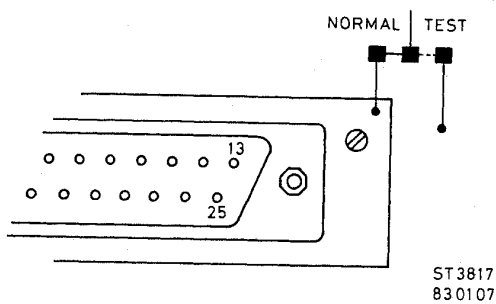



- Interconnect on the IEC-BUS connector
  - signal DAV with EO1,
  - signal REN with ground

- Connect the signature analyser to the PM2528 as given in the settings table.
- Connect the test switch to the PM2528 (refer to 11.1.).
- Switch on the PM2528 and select *TEST 11*.

TEST ADDRESS DECODER (Self-running with own clock).

Settings signature analyser

| Setting | Edge  | Test pin | Signal name |
|---------|---|----------|-------------|
| START   |  | D3210/9  | red         |
| STOP    |  | D3210/9  | red         |
| CLOCK   |  | D3216/15 | Cl          |
| QUAL.   | —   | —        | —           |
| GROUND  | —   | TP -5V   | Logic 0     |

## Preparations

Refer to test 11.

How to measure signal INSR (D3210/3) LOGIC 1 = 0UP7

## Measuring sequence

| Settings |         |     |       | Sequence       |
|----------|---------|-----|-------|----------------|
| 1        | Address | 22  | - SRQ | 0C03           |
| 2        | Address | 22  | + SRQ | US* (Unstable) |
| 3        | Only    |     | - SRQ | 0010           |
| 4        | Only    | TON | - SRQ | 0050           |
| 5        | Only    | A1  | - SRQ | 0091           |
| 6        | Only    | A2  | - SRQ | 0112           |
| 7        | Only    | A3  | - SRQ | 0215           |
| 8        | Only    | A4  | - SRQ | 041A           |
| 9        | Only    | A5  | - SRQ | 0804           |

+SRQ = SRQ off in position off = SRQ

SRQ = SRQ off in position on = SRQ

