

This manual is for reference and historical purposes, all rights reserved.

**This page is copyright© by M. Butkus, NJ.**

This page may not be sold or distributed without the expressed permission of the producer

I have no connection with any camera company

On-line camera manual library

This is the full text and images from the manual. This may take 3 full minutes for the PDF file to download.

**If you find this manual useful, how about a donation of \$3 to: M. Butkus, 29 Lake Ave., High Bridge, NJ 08829-1701 and send your e-mail address so I can thank you. Most other places would charge you \$7.50 for a electronic copy or \$18.00 for a hard to read Xerox copy.**

**This will allow me to continue to buy new manuals and pay their shipping costs.**

**It'll make you feel better, won't it?**

**If you use Pay Pal or wish to use your credit card,  
click on the secure site on my main page.**

PayPal Name Lynn@butkus.org

**ASAHI  
PENTAX**

# DIGITAL SPOTMETER



[www.butkus.us](http://www.butkus.us)

## SPECIFICATIONS

---

<b>Measuring Range:</b>	(100 ASA) EV 1 - 20 (EV 20 displayed as "0").
<b>Scales:</b>	ASA, 6 - 6400; Shutter Speed, 1/4000 sec. - 4 min.; Aperture, f/1 - 128; EV Number, 1 - 19-2/3; IRE, 1 - 10.
<b>Measuring Angle:</b>	1°.
<b>Measuring Distances:</b>	From about 1.5m to infinity - fixed focal length. (Focusing down to about 1m possible by screwing the eyepiece out as far as it will go).
<b>Measuring Method:</b>	Spot measuring of reflected light. (Meter switches on when button pressed).
<b>Exposure Read-Out:</b>	LED digital display of EV Numbers (100 ASA), and up to two dots (each of which equals + 1/3 EV).
<b>Photosensitive Cell:</b>	Silicon Photo Diode.
<b>Power Source:</b>	One 6V silver oxide battery (No. 544 or equivalent) or No. 537 alkaline battery.
<b>Battery Check:</b>	Failure of LED digital display to illuminate indicates battery needs replacing.

---

---

<b>Viewfinder:</b>	Pentaprism type with unreversed, laterally correct image. Objective and eyepiece lenses Super-Multi-Coated and pentaprism specially silvered for brilliant viewfinder image. Even illumination achieved with finely grooved fresnel lens. 1° spot indicated in center of viewfinder, and large LED Panel appears at the bottom. Viewfinder coverage similar in shape to that of a 35mm SLR, and with a diagonal field of view of 26°, horizontal field of 22°, and vertical field of 14°, adjustable eyepiece of -2 to +1 diopter.
<b>Filter Size:</b>	40.5mm.
<b>Dimensions:</b>	44mm(D) x 144mm(H) x 83mm(W).
<b>Weight:</b>	258g (with battery).
<b>Additional:</b>	Equipped with Tripod Socket, supplied with case, Wrist Strap, battery, and Lens Cap.

---

# NOMENCLATURE

1

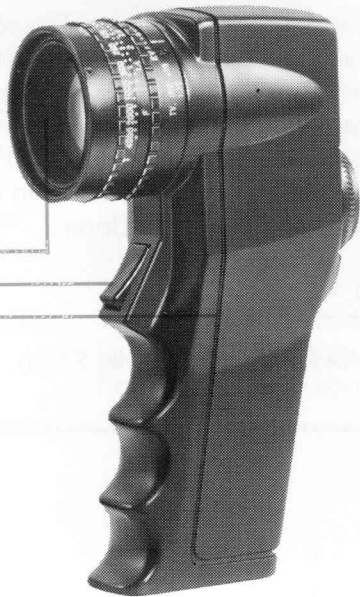

- Objective Lens
- Metering Button
- Grip

2



- ASA Index
- ASA Scale
- ASA/Shutter Speed Dial
- Shutter Speed Scale
- Aperture Scale
- Aperture/EV No. Dial
- EV No. Scale
- IRE Scale
- IRE Standard Index

# NOMENCLATURE

1

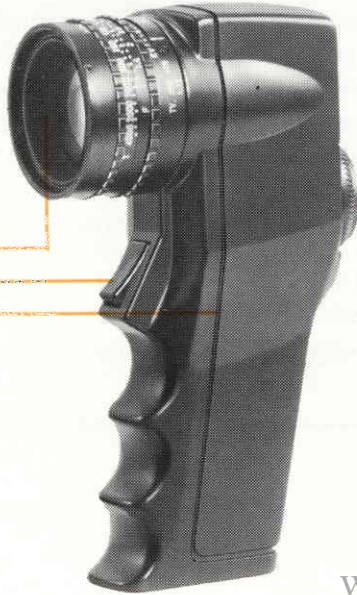

- Objective Lens
- Metering Button
- Grip

2

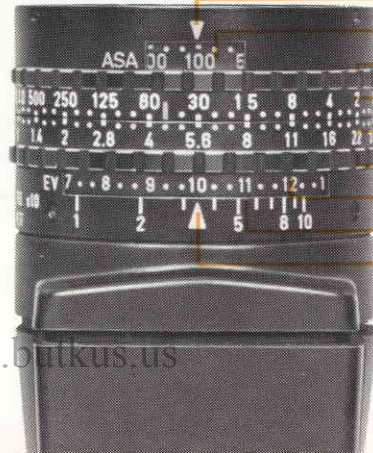

- ASA Index
- ASA Scale
- ASA/Shutter Speed Dial
- Shutter Speed Scale
- Aperture Scale
- Aperture/EV No. Dial
- EV No. Scale
- IRE Scale
- IRE Standard Index

3

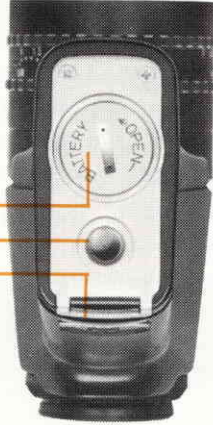

Battery Chamber Cover

Tripod Socket

Wrist Strap Eyelet

4



Eyepiece Adjustment  
Lock Ring

Eyepiece Lens

Eyepiece (Rubber) Frame

3

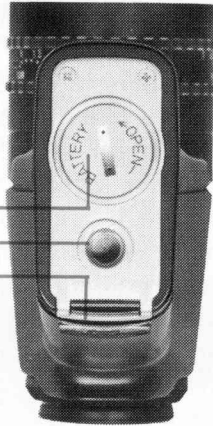

- Battery Chamber Cover
- Tripod Socket
- Wrist Strap Eyelet

4

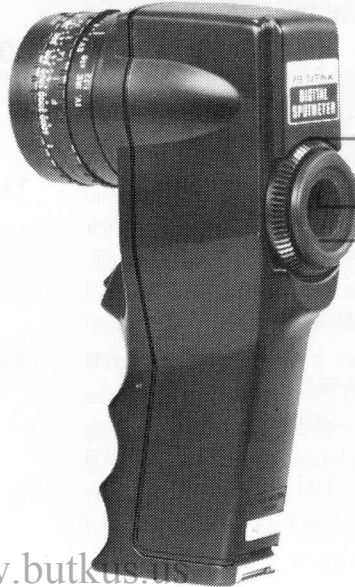

- Eyepiece Adjustment Lock Ring
- Eyepiece Lens
- Eyepiece (Rubber) Frame



## SPECIAL FEATURES

1. Small enough to be pocketable.
2. Light enough to carry anywhere.
3. Strongly resistant to shock (no moving parts in exposure measurement system).
4. LED digital display visible under any lighting condition.
5. Can follow the fastest action and work in the dimmest surroundings because of the instantaneous response of the Silicon Photo Diode.
6. Human engineered for the perfect grip and optimum handling ease.
7. Objective and eyepiece lenses Super-Multi-Coated and pentaprism specially silvered for brilliant viewing.
8. Stabilizer Circuit eliminates LED flicker for comfortable viewing.
9. Digital display exceptionally large for viewing ease.
10. Digital display (EV No., 100 ASA) given in 1/3 EV steps to match the ASA, Shutter Speed, Aperture, and EV No. Scales for precise and easy to make settings.
11. The minute  $1^{\circ}$  angle of view of the Digital Spotmeter is equivalent to a 40 power ultra-telephoto lens, making it possible to take accurate exposure measurements of a distant subject.
12. Only with a spotmeter is it possible to separately measure all of the tones of a given subject, from the brightest highlight to the darkest shadow.

## BATTERIES

### INSERTING THE BATTERY

**Illust. 5,** Rotate counterclockwise with a coin and remove the Battery Chamber Cover ① found on the base plate of the Grip.

**Illust. 6,** Insert, plus-side-down, a 6V silver oxide battery (No. 544 or equivalent) or a No. 537

5

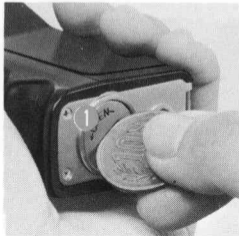

6



alkaline battery into the Battery Chamber, and replace cover (minus side of battery faces cover).

### BATTERY LIFE

A Battery Check Circuit is connected to the LED digital display so that illumination of the display indicates battery condition is good. If the digital display appears faint or fails to illuminate, the battery should immediately be replaced. Battery life is considerable, and even with constant use the battery should last a year; nevertheless, it is always advisable to carry a spare battery to be prepared for emergencies.

Electricity will not be consumed as long as the Metering Button is not pressed, even when light enters the Objective Lens. However, even when not used, maximum battery life is two years.

## OUTLINE OF OPERATING PROCEDURE

**Illust. 7 & 8**, While looking through the viewfinder ( ② , illust. 8) at a distant object, rotate counter-clockwise the Eyepiece Adjustment Lock Ring ( ③ , illust. 8 & 9) until the small circle in the center of the viewfinder ( $1^\circ$  spot) appears sharp. Next, squeeze the Metering Button ( ⑧ , illust. 11) to determine whether the digital display (illust. 7) also appears sharp. If it does not appear sharp,

7

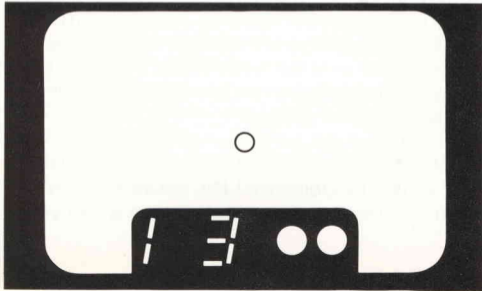

readjust the Eyepiece Adjustment Lock Ring to a midway point so that both the digital display and  $1^\circ$  spot appear reasonably sharp.

**Illust. 9**, After adjusting the eyepiece for maximum sharpness, hold the rubber Eyepiece Frame securely ( ④ , illust. 9) so that it does not move, and lock it into place by rotating the Eyepiece Adjustment Lock Ring ( ③ , illust. 9) clockwise

8

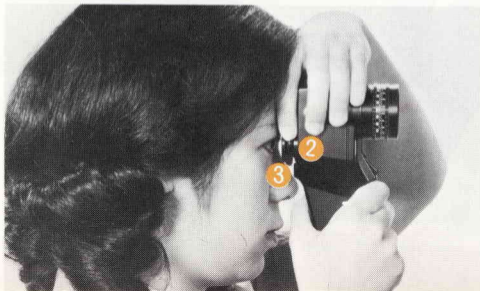

until it stops. When someone else is to use the spotmeter, rotate the Eyepiece Adjustment Lock Ring counterclockwise to loosen eyepiece, readjust eyepiece, and lock it into place once again.

**Illust. 10**, Align the ASA No. of the film being used with the green ASA Index (7), illust. 10) by rotating the ASA/Shutter Speed Dial (6) which is close to the front of the lens (5). The figures of the ASA Scale also appear in green.

9

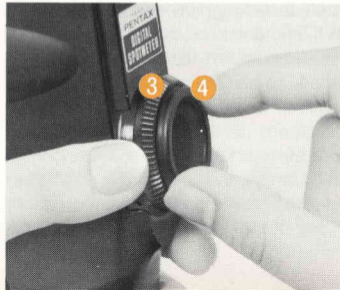

10

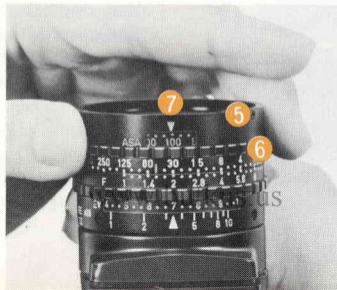

11



**Illust. 11**, While holding the spotmeter up to your eye, align the 1° spot in the center of the viewfinder with the part of the subject you wish to measure. Squeeze the Metering Button and an LED digital display will appear. In illust. 7, the digital display indicates 13-2/3 EV; if a single dot appeared, it would indicate 13-1/3 EV, and if no dot appeared, it would indicate exactly 13 EV.

## 12-1•2

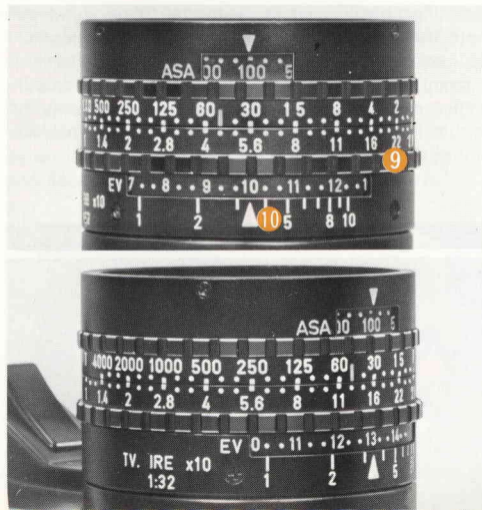

**Illust. 12-1 & 12-2,** Align the EV No. indicated by the digital display with the IRE Standard Index ( ⑩ ) by rotating the Aperture/EV No. Dial ( ⑨ ). Both the IRE Standard Index and the numerals of the EV No. Scale are colored Orange. After aligning the EV No. with the Standard Index, merely select any aperture-shutter speed combination indicated on the respective scales. In illust. 12-2, for example, it can be seen that when the ASA setting is 100 and EV No. 13 is aligned with the Standard Index, any of the following combinations result in correct exposure:  
 f/1.4, 1/4000 sec., f/2, 1/2000 sec. . . . .  
 f/22, 1/15 sec.

## CINE INDEX

The operation of the spotmeter for movie cameras differs somewhat from that of still photography.

The shutter speed of movie cameras is determined by camera type, the shutter opening angle, and whether the camera is being used for high or low speed photography.

The standard shutter speed of the ordinary 35 and 16mm movie camera is approximately  $1/50$  of a second (24 frames per second). This speed is marked in red on the Shutter Speed Scale between the  $1/30$  and  $1/60$  sec. divisions. Therefore, when using the meter with these cameras, the aperture opening is found on the Aperture Scale below this mark.

With 8mm movie cameras, the Super-8 and Single-8 types take 18 frames per second, and the Double-8 type takes 16 frames per second. In both cases, the proper aperture opening will be found on the Aperture Scale below the  $1/30$  sec. mark.

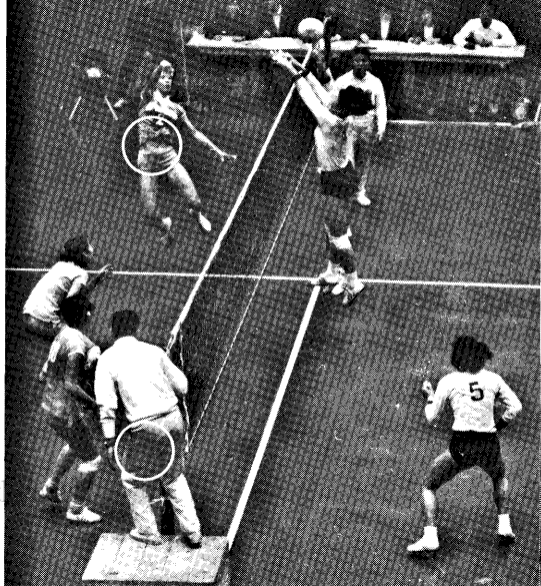

## IRE (INSTITUTE OF RADIO ENGINEERS) SCALE

The Pentax Digital Spotmeter is provided with an IRE Scale which is very useful for television filming and movie making, as well as general photography. 120 Pentax Spotmeter II's equipped with IRE Scales were used to provide exposure settings for the making of the official film of the 1964 Tokyo Olympics. Since that time, this scale has come to be used whenever comparable precision in exposure setting is called for.

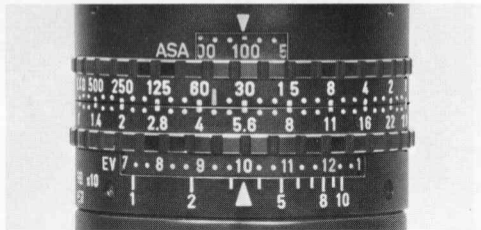

**IRE** units provide a means for the percentage-wise comparison of energy. The maximum energy value is taken to be 100% and energy levels taking this maximum as a standard are expressed as percentages of maximum level. This method is used in radio communications to compare signal voltages, but is also applicable to the comparison of light energy obtained in exposure measurements. The light level of the brightest highlight in the subject is taken as 100% and the energy of other parts of the subject is expressed in IRE units as a fraction of that level.

**Index 10** (100% IRE) indicates the level of the brightest highlight in the picture, the upper brightness limit, and is called the "white level."

**Index 1** (10% IRE) shows the maximum darkness of shadow detail reproducible on the film. This is called the "Black level."

The intermediate numbers 9 ~ 2 (90 ~ 20% IRE) indicate comparative brightness based on the 100% "White level." These indices represent divisions of the linear gray scale.

The large orange triangular index between 3 and 4 is the **Standard Index**, in use on most light meters, which shows the average of optimum film exposure levels (light level obtained using standard reflecting surface, reflectivity ratio of 18%).

The figure "1:32" at the extreme left of the scale indicates the contrast ratio between IRE scale 1 and 10. The IRE scales from 1 to 10 cover 5 light level numbers. Since an increase of one EV number represents a doubling of light level, the contrast ratio is 1:32 ( $2^5 = 32$ ).

[www.butkus.us](http://www.butkus.us)





## VARIOUS METHODS OF EXPOSURE READINGS

**Methods of exposure reading include the half-tone reading method, the averaging method, the highlight reading method, and the shadow reading method.**

### HALF-TONE READING METHOD

Center the 1° spot on a half-tone area of primary interest and take the reading for that point. If, for example, the subject is a person, aim the 1° spot at his or her face. If the subject is an object or a landscape, select an area of average tonal quality and place the 1° spot in that area.

After reading the light level, align this number with the IRE Standard Index. Select an appropriate set of values for shutter speed and aperture opening from the two scales in the center of the exposure calculator.

The spotmeter will prove itself especially valuable for measuring exposure of persons standing under stage spotlights and in similarly difficult situations. Since the half-tone method measures in half-tone only, it is very simple, but the clue to success lies in the way in which the half-tone reflectivity ratio is measured. Measure the gray 18 percent standard reflection card directly or else something with a reflectivity ratio very close to it to get the best results.

### AVERAGING METHOD

Measure the highlight (brightest) and shadow (darkest) areas and take the average of the readings obtained. The best results will be obtained if the difference between the highlights and shadows is no greater than the reproducible contrast ratio of the film. For black and white

reversal film this difference is approximately 7 EV numbers; for color reversal film and black and white prints it is approximately 5 EV numbers. With color prints, the difference is less than 5 EV numbers. If the contrast between highlights and shadows exceeds these ranges, measure the light of at least three locations in the picture area and divide the sum of readings by the number of locations measured to obtain an average value. Set this average value by the Standard Index. In this case the highlight areas beyond the film's reproducibility range will be overexposed, or the shadow areas will be underexposed. By this method, however, one will have obtained correct exposure for the greatest area of the picture as a whole.

[www.butkus.us](http://www.butkus.us)

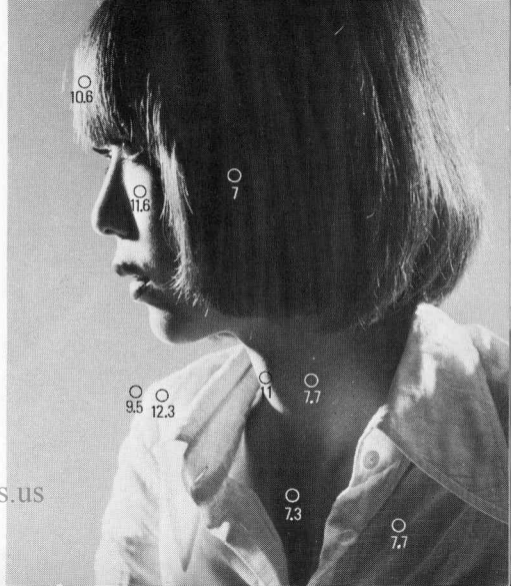



## FOR THE SPECIALIST

### HIGHLIGHT READING METHOD

This is a method for which the Pentax Digital Spotmeter is uniquely adapted. In this case, the light level of the subject highlights are made the base value for exposure setting. This method was developed for television filming, but is just as useful for still and moving picture photography. As previously mentioned, the maximum reproducible contrast ratio differs according to film type, but generally speaking this ratio is the same for color film as for television broadcasting, about 1:32. The ratio for black and white film is approximately 1:128. To use this method, the light level of the highlights is first determined, and this EV value taken as the upper exposure limit. By doing this the optimum exposure will be based on the light areas.

The light level read at the highlights is set on the exposure calculator by **index 10 of the IRE Scale**. With color film, only those shadows with a light level reading falling to the right of index 1 of the IRE scale (black level) will be reproduced. Areas with a light value falling below index 1 will appear as unrelieved shadow.

Therefore, when the light level of the highlights has been set on index 10, if important shadow detail has insufficient light to bring it above index 1, it will have to be given additional illumination until its light level reading does exceed this mark.

## EXPOSURE FOR SPECIAL EFFECTS

Highlight metering is also a convenient means of achieving an underexposed, low-key effect which is desirable when creating a nocturnal atmosphere in a daytime shot.

To achieve this effect, read the light level of the highlights, and set this number on the exposure calculator by one of the IRE indexes chosen in accordance with the degree of density desired in the resulting photograph.

For example, if the light level of the highlights is EV 16, and this value is set on the exposure calculator by the standard index, the highlights will be reproduced in a gray tone as if they were a standard 18% reflective surface.



## SHADOW READING METHOD

The reverse of the highlight reading method, this method gives an optimum exposure based on the shadow areas. Shadow reading is employed for bringing out detail of persons photographed with backlighting, and for fully reproducing shadow detail in pictures taken at night.

When ordinary light meters are used to set exposure for evening or nighttime scenes which are not brightly illuminated by neon or other lighting, the resulting photograph has the same appearance as a daytime scene. By using the spotmeter and the shadow reading method, exposures can be set to give evening scenes an "Evening-look" and nighttime scenes a "Nighttime-look."

Read the light values of the shadow areas it is desired to reproduce, and set this light level on the exposure calculator by IRE index 1.

In this case, areas of light value falling between indexes 1 and 10 on the IRE Scale will be reproducible on color film. Areas of light value falling above index 10 will be washed out.

Consequently, if important highlight detail has a light level falling above index 10 when shadow light level has been set according to index 1, it will be necessary to reduce illumination of the highlight area, or to reduce the reflectivity of the highlight, until its light level falls on or below index 10.

[www.butkus.us](http://www.butkus.us)



## LIGHT REFLECTIVITY OF 7 COLORS

Color	Reflectivity (%)	Index No.
Red (bright red)	15 ~ 21	5
Orange	35 ~ 45	6 ~ 7
Yellow (dark yellow)	65 ~ 75	8
Green (dark leaf-green)	18 ~ 26	Standard Index
Blue	15 ~ 21	5
Indigo	6 ~ 12	2 ~ 3
Purple	6 ~ 12	2 ~ 3

## DON'T BE MISGUIDED BY COLORS

You should be careful about colors when using the Digital Spotmeter. If exposure is set strictly on the basis of a light level reading taken from a color area, there is a good possibility that the exposure will be incorrect. This is because reflectivity is different for different colors. The reflectivity of yellow is lower than that of white, but yellow has the highest reflectivity of all the colors. Indigo and purple have the lowest reflectivity. Consequently, if a light level value taken from a reading of a yellow area is set on the exposure calculator according to the standard index, the photograph will be somewhat underexposed. To prevent this, set light readings taken from the various colors according to the corresponding index number listed in the table on the left.

## EV – LUMINANCE CONVERSION TABLE

EV	cd/m <sup>2</sup>	cd/ft <sup>2</sup>	ft-L
1	0.28	0.026	0.082
2	0.56	0.052	0.164
3	1.1	0.1	0.3
4	2.2	0.2	0.7
5	4.5	0.4	1.3
6	9.0	0.8	2.6
7	17.9	1.7	5.2
8	35.8	3.3	10.4
9	71.6	6.7	20.9
10	143	13.3	41.7
11	286	26.6	83.5
12	573	53.2	167
13	1,150	107	336
14	2,290	213	668
15	4,580	425	1,340
16	9,170	852	2,680
17	18,300	1,700	5,340
18	36,700	3,410	10,700
19	73,400	6,820	21,400

When the spotmeter is used to take a reading of ordinary objects, the light level value obtained is not convertible into luminance. Conversion is possible only against a standard 18% reflecting surface.





## CLOSE-UP READING

Because of the extremely narrow  $1^\circ$  measuring angle, light metering of a point should be possible with the Pentax Spotmeter V without approaching the subject. Consequently, there is no need to bring things into sharp focus as with a camera. Nevertheless, if it should be necessary to come extremely close to the subject in order to measure a very small point, the fact that the objective lens is of fixed focus might make viewing difficult. In such a case, unscrewing the adjustable eyepiece to the limit of its travel will make viewing a little easier. It will be noticed, however, that the digital display is now out of focus, and readjustment may be necessary to read the value indicated.

## SELECTING FILTERS

When photographing colored objects with black and white film, it is necessary to take into account the reflectivity of each of the colors. While contrast between adjacent colors may appear good to the eye, if their reflectivities are nearly the same, the contrast in the resulting black and white photograph will be disappointing. As is well known, the use of color filters can improve contrast in cases such as the above, but it is difficult to judge which filter to use.

By mounting different filters in front of the objective lens of the Pentax Spotmeter and comparing the readings taken of the various colored areas with each filter, it will be easy to determine which one provides the best contrast for black and white film.

## USE IN SELECTING COLORS

The age of color has arrived in television broadcasting, but while almost all movies now televised are in color, they are viewed on black and white television sets as well as color. For this reason it will not do to make movies for television broadcasting which are attractive in color, but drab in black and white.

Thus, it is necessary to consider color distribution and composition, as well as simple light values, when filming for color television.

If light values are determined with a Pentax Digital Spotmeter, not only will the brightness contrast be known, but the proper choice of colors can be decided as well. This principle is being utilized now in the creation of displays and designs of all types.

## WRIST STRAP ADJUSTMENT

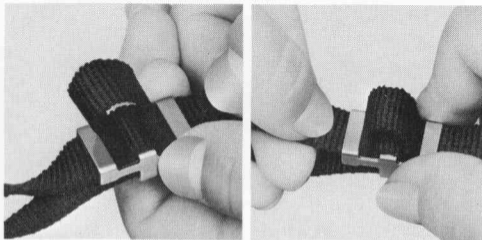

- 1.** As shown in the accompanying photographs, the wrist strap can be adjusted by pushing the strap into the clip from one direction and then pulling on it in the opposite direction until the desired length is obtained.
- 2.** As the wrist strap protrudes through an opening in the lower part of the case, the Spotmeter can be placed in its case without removing the wrist strap.
- 3.** When desiring to support the Spotmeter from your neck or shoulder, use the neck strap available as an optional accessory.

## TRIPOD MOUNTING

1. If the Digital Spotmeter cannot be held steadily enough by hand, it can be mounted on a tripod and used from there.
2. As shown in the photograph, the Digital Spotmeter is equipped with a Tripod Socket for mounting on any standard tripod. The Spotmeter can be mounted on the tripod with the wrist strap in place.

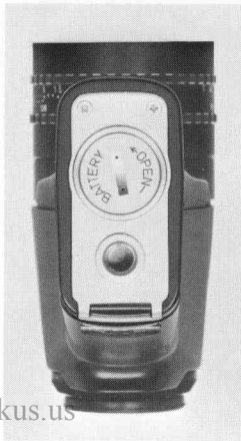

[www.butkus.us](http://www.butkus.us)

## PRECAUTIONS

1. If the Metering Button is squeezed when the lens cap covers the Objective Lens, the digital display will indicate "0" (zero), but if a small amount of light enters the lens, the digital display will indicate 0 ● or 0 ● ●. However, since the exposure measurement range of the Digital Spotmeter is EV 1 - 20 (100 ASA), do not use measurements which fall below EV 1.

2. Reflections near the vicinity of the Silicon Photo Diode have been greatly reduced due to the new design incorporated into Spotmeter V and the Digital Spotmeter. Because of their exceptional efficiency, the readings you obtain may be slightly lower than those of other spotmeters. Therefore, if you detect such a difference, do not be concerned.

3. When taking a reading from a dimly-lit subject (e.g. EV 3 or below) and then immediately changing to a bright subject (e.g. EV 6 or above), the response of the Silicon Photo Diode will be instantaneous and a correct reading will be obtained. On the other hand, when first removing the lens cap and commencing the first exposure reading, a few seconds may be necessary before receiving the correct exposure measurement.

Size of the 1° metering angle of the Digital Spotmeter relative to the field of vision obtained with various lenses used with 35mm cameras.

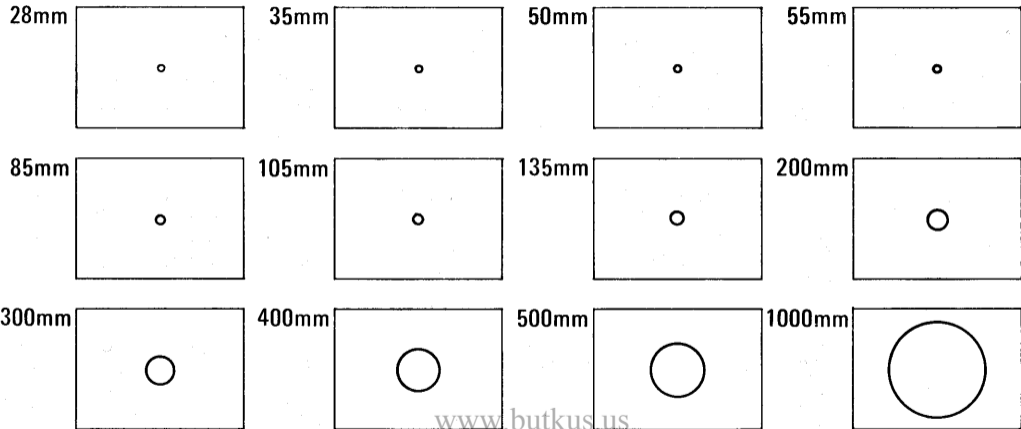

www.butkus.us